

# **Trailer Mount Tailgate Spreaders Installation Instructions**

**⚠ CAUTION**

**Read Owner's Manual before operating or servicing spreader.**

# SAFETY INFORMATION

## SAFETY DEFINITIONS

### **⚠ WARNING**

Indicates a potentially hazardous situation that, if not avoided, could result in death or serious personal injury.

### **⚠ CAUTION**

Indicates a potentially hazardous situation that, if not avoided, may result in minor to moderate injury. It may also be used to alert against unsafe practices.

**NOTE:** Indicates a situation or action that can lead to damage to your spreader and vehicle or other property. Other useful information can also be described.

## WARNING/CAUTION LABELS

Please become familiar with the Warning and Caution labels on the spreader.

**NOTE:** If labels are missing or cannot be read, see your sales outlet.

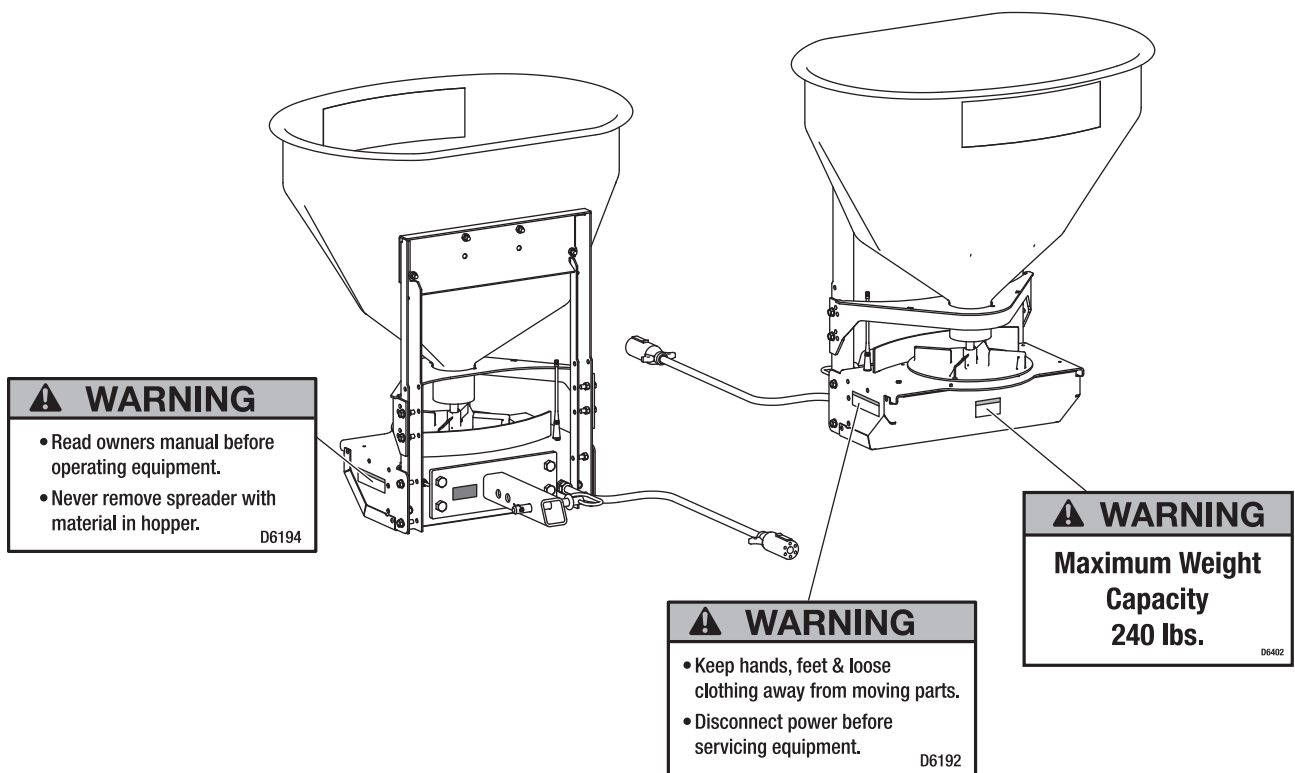

# SAFETY INFORMATION

## SAFETY PRECAUTIONS

Improper installation and operation could cause personal injury and/or equipment and property damage. Read and understand labels and the Owner's Manual before installing, operating or making adjustments.

### **⚠ WARNING**

- Driver to keep bystanders minimum of 25 feet away from operating spreader.
- Before working with the spreader, secure all loose-fitting clothing and unrestrained hair.
- Before operating the spreader, verify that all safety guards are in place.
- Before servicing the spreader, wait for conveyor or spinner to stop, then lock out power.
- Do not climb into or ride on spreader.

### **⚠ WARNING**

Overloading could result in an accident or damage. Do not exceed GVWR or GAWR ratings as found on the driver-side vehicle door cornerpost. See Loading section to determine maximum volumes of spreading material.

### **⚠ CAUTION**

If rear directional, CHMSL light or brake stoplights are obstructed by the spreader, the lights shall be relocated, or auxiliary directional or brake stoplights shall be installed.

### **⚠ CAUTION**

During the hopper installation we recommend the addition of an OSHA compliant Backup Alarm. This alarm is required for OSHA governed employers.

### **⚠ CAUTION**

- Do not operate a spreader in need of maintenance.
- Before operating the spreader, reassemble any parts or hardware removed for cleaning or adjusting.
- Before operating the spreader, remove materials such as cleaning rags, brushes, and hand tools from the spreader.
- While operating the spreader, use auxiliary warning lights, except when prohibited by law.
- Tighten all fasteners according to the Torque Chart. Refer to Torque Chart for the recommended torque values.

### **⚠ CAUTION**

Disconnect electric and/or hydraulic power and tag out if required before servicing or performing maintenance.

### **⚠ CAUTION**

DO NOT leave unused material in hopper. Material can freeze or solidify, causing unit to not work properly. Empty and clean after each use.

**NOTE:** Lubricate grease fittings after each use. Use a good quality multipurpose grease.

## PERSONAL SAFETY

- Remove ignition key and put the vehicle in park or in gear to prevent others from starting the vehicle during installation or service.
- Wear only snug-fitting clothing while working on your vehicle or spreader.
- Do not wear jewelry or a necktie, and secure long hair.
- Wear safety goggles to protect your eyes from battery acid, gasoline, dirt and dust.
- Avoid touching hot surfaces such as the engine, radiator, hoses and exhaust pipes.
- Always have a fire extinguisher rated BC handy, for flammable liquids and electrical fires.

# SAFETY INFORMATION

---

## FIRE AND EXPLOSION

### **⚠ WARNING**

**Gasoline is highly flammable and gasoline vapor is explosive. Never smoke while working on vehicle. Keep all open flames away from gasoline tank and lines. Wipe up any spilled gasoline immediately.**

Be careful when using gasoline. Do not use gasoline to clean parts. Store only in approved containers away from sources of heat or flame.

## CELL PHONES

A driver's first responsibility is the safe operation of the vehicle. The most important thing you can do to prevent a crash is to avoid distractions and pay attention to the road. Wait until it is safe to operate Mobile Communication Equipment such as cell phones, text messaging devices, pagers or two-way radios.

## VENTILATION

### **⚠ WARNING**

**Vehicle exhaust contains lethal fumes. Breathing these fumes, even in low concentrations, can cause death. Never operate a vehicle in an enclosed area without venting exhaust to the outside.**

## BATTERY SAFETY

### **⚠ CAUTION**

**Batteries normally produce explosive gases, which can cause personal injury. Therefore, do not allow flames, sparks, or lit tobacco to come near battery. When charging or working near a battery, always cover your face and protect your eyes, and also provide ventilation.**

- **Batteries contain sulfuric acid, which burns skin, eyes and clothing.**
- **Disconnect the battery before removing or replacing any electrical components.**

## NOISE

Airborne noise emission during use is below 70 dB(A) for the spreader operator.

## VIBRATION

Operating snowplow vibration does not exceed 2.5 m/s<sup>2</sup> to the hand-arm or 0.5 m/s<sup>2</sup> to the whole body.





## TORQUE CHART

### CAUTION





Read instructions before assembling. Fasteners should be finger tight until instructed to tighten according to torque chart. Use standard methods and practices when attaching spreader including proper personal protective safety equipment.

#### Recommended Fastener Torque Chart

##### Inch Fasteners Grade 5 and Grade 8

Size	Torque (ft-lb)		Size	Torque (ft-lb)	
	 Grade 5	 Grade 8		 Grade 5	 Grade 8
1/4-20	8.4	11.9	9/16-12	109	154
1/4-28	9.7	13.7	9/16-18	121	171
5/16-18	17.4	24.6	5/8-11	150	212
5/16-24	19.2	27.3	5/8-18	170	240
3/8-16	30.8	43.6	3/4-10	269	376
3/8-24	35.0	49.4	3/4-16	297	420
7/16-14	49.4	69.8	7/8-9	429	606
7/16-20	55.2	77.9	7/8-14	474	669
1/2-13	75.3	106.4	1-8	644	909
1/2-20	85.0	120.0	1-12	704	995

##### Metric Fasteners Class 8.8 and 10.9

Size	Torque (ft-lb)		Size	Torque (ft-lb)	
	 Class 8.8	 Class 10.9		 Class 8.8	 Class 10.9
M6 x 1.00	7.7	11.1	M20 x 2.50	325	450
M8 x 1.25	19.5	26.9	M22 x 2.50	428	613
M10 x 1.50	38.5	53.3	M24 x 3.00	562	778
M12 x 1.75	67	93	M27 x 3.00	796	1139
M14 x 2.00	107	148	M30 x 3.50	1117	1545
M16 x 2.00	167	231	M33 x 3.50	1468	2101
M18 x 2.50	222	318	M36 x 4.00	1952	2701

These torque values apply to fasteners except those noted in the instructions.

# LOADING

This Manual covers vehicles which have been recommended for carrying the spreader. Please see your local dealer for proper vehicle applications.

## CERTIFICATION

### WARNING

New untitled vehicle installation of a spreader requires National Highway Traffic Safety Administration altered vehicle certification labeling. Installer to verify that struck load of snow or ice control material does not exceed GVWR or GAWR rating label and complies with FMVSS.

## APPROXIMATE MATERIAL WEIGHTS

### WARNING

Overloading could result in an accident or damage. Do not exceed GVWR or GAWR as found on the driver-side cornerpost of vehicle.

### WARNING

Do not overload vehicle. Use chart below to calculate weight of material. Weights of material are an average for dry materials.

### CAUTION

Never use wet materials or materials with foreign debris with any of these spreaders. These units are designed to handle dry, clean, free flowing material.

### CAUTION



Read and adhere to manufacturer's ice-control material package labeling including Material Safety Data Sheet requirements.

Material	Density (lb/ft <sup>3</sup> )
Rock Salt (Dry)	80–90

Weight of spreader and mount must be added to struck material weight to determine total spreader weight. Do not exceed maximum material capacity as shown on the safety label (see Safety Information section).

Use only bagged rock salt with the spreader. Other forms of spreading material are not compatible with the tailgate spreader.

**NOTE:** If spreader and ice control material loading is in doubt, weigh vehicle for compliance with vehicle ratings.

# TRAILER MOUNT INSTALLATION

---

## Drop Utility Mount Installation

---

**NOTE: Remove any existing trailer hitch and other after-market equipment that may interfere with the installation of this product according to these instructions.**

---

1. Insert the axle through the wheel and the axle weldment.
2. Put the 5/8" flat washer on the axle. Install the hairpin cotter to secure the axle. Repeat steps 1 and 2 for the other side.
3. Attach the receiver mount to the a-frame using 1/2" x 1-1/2" cap screws and 1/2" locknuts.
4. Insert the trailer tongue as shown and secure using the hitch pin and hairpin cotter.
5. Insert the spreader mount into the other end of the receiver mount and pin into place.

# TRAILER MOUNT INSTALLATION

---

The company reserves the right under its product improvement policy to change construction or design details and furnish equipment when so altered without reference to illustrations or specifications used. This equipment manufacturer or the vehicle manufacturer may require or recommend optional equipment for spreaders. Do not exceed vehicle ratings with a spreader. The company offers a limited warranty for all spreaders and accessories. See separately printed page for this important information. The company offers a limited warranty for all spreaders and accessories. See separately printed page for this important information. Club Car® is a registered trademark of Club Car, LLC. Gator™ is an unregistered trademark of Deere & Company. Kawasaki® and Mule™ are registered and unregistered trademarks of Kawasaki Motors Corp., U.S.A.

**Printed in U.S.A.**

---