



Minute² Mount[®]

SYSTEM

MOUNT KIT

Chevrolet Colorado	2004 - 09
GMC Canyon	2002 - 09
Chevrolet Colorado w/o Z71 or Off-Road	2010 - 12
GMC Canyon w/o Z71 or Off-Road	2010 - 12

Installation Instructions

⚠ CAUTION

Read this document before installing the snowplow.

⚠ CAUTION

See your FISHER[®] outlet/website for specific vehicle application recommendations before installation. The eMatch tool has specific vehicle and snowplow requirements.

SAFETY DEFINITIONS

⚠ WARNING
 Indicates a potentially hazardous situation that, if not avoided, could result in death or serious personal injury.

⚠ CAUTION
 Indicates a potentially hazardous situation that, if not avoided, may result in minor or moderate injury. It may also be used to alert against unsafe practices.





NOTE: Indicates a situation or action that can lead to damage to your snowplow and vehicle or other property. Other useful information can also be described.

WARNING/CAUTION AND INSTRUCTION LABELS

Become familiar with and inform users about the warning labels on the back of the blade and the instruction label on the headgear.

NOTE: If labels are missing or cannot be read, see your sales outlet.

Warning/Caution Label

⚠ WARNING	
	Lower blade when vehicle is parked.
	Do not exceed GVWR or GAWR including blade and ballast.
⚠ CAUTION	
	Read Owner's Manual before operating or servicing snowplow.
	Transport speed should not exceed 45 mph (72 km/h). Further reduce speed under adverse travel conditions.
	Plowing speed should not exceed 10 mph (16 km/h).
See your sales outlet/Web site for specific vehicle application recommendations. 59903	

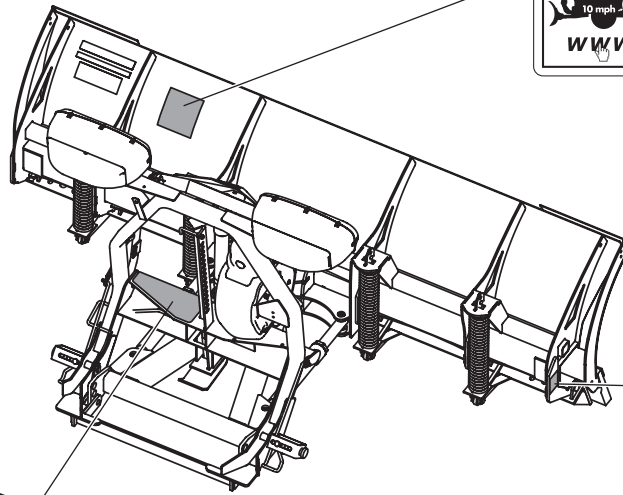

Multiple Pinch Points Label

⚠ WARNING	
	
Multiple Pinch Points	

XLSTM™ Blades Only (both sides)

Instruction Label

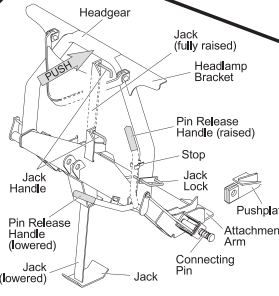
	<ol style="list-style-type: none"> Push Pin Release Handle down to pull out Connecting Pins. Drive vehicle slowly to engage Pushplates into Attachment Arms. Stand in front of blade. Fully raise Pin Release Handle to release Connecting Pins. Push Headgear toward vehicle to allow Connecting Pins to fully engage Pushplates. If unable to push Headgear from in front of blade, stand in front of Headgear on driver side and push Headlamp Bracket. Pull out Jack Lock. Push Pin Release Handle into Stop. While holding Jack Lock out, use Jack Handle to raise Jack fully. Release Jack Lock. Attach all electrical connectors. <p style="text-align: center;">Read Owner's Manual for complete instructions.</p>
<ol style="list-style-type: none"> Place control in Lower/Float to put blade down. Pull and hold Jack Lock out. Jack will drop to ground. Then pull Pin Release Handle away from Stop and Jack Lock. Release Jack Lock. Verify that Jack is locked by trying to lift Jack. Stand in front of blade. While pushing Headgear toward vehicle with left hand, push Pin Release Handle down to disengage Connecting Pins. Make sure Connecting Pins are fully retracted. If unable to push Headgear from in front of blade, stand in front of Headgear on driver side and push Headlamp Bracket. Detach all electrical connectors. 	<p>ATTACH</p> <p>DETACH</p>

U.S. patents: 5,638,818; 5,999,007; 6,253,470; 6,408,549; 6,526,877; 6,711,837; 6,928,797; 6,944,978; 7,400,090; 7,430,921; 7,691,334; 7,737,076; 7,797,809; CAN patents: 2,184,922; 2,229,783; 2,354,257; 2,356,036; 2,632,102; 2,639,052; and other patents pending.

SAFETY PRECAUTIONS

Improper installation and operation could cause personal injury and/or equipment and property damage. Read and understand labels and the Owner's Manual before installing, operating or making adjustments.

⚠ WARNING

Lower the blade when vehicle is parked. Temperature changes could change hydraulic pressure, causing the blade to drop unexpectedly or damaging hydraulic components. Failure to do this could result in serious personal injury.

⚠ WARNING

The driver shall keep bystanders clear of the blade when it is being raised, lowered or angled. Do not stand between the vehicle and the blade or within 8 feet of a moving blade. A moving or falling blade could cause personal injury.

⚠ WARNING

Keep hands and feet clear of the blade and A-frame when mounting or removing the snowplow. Moving or falling assemblies could cause personal injury.

⚠ WARNING

Do not exceed GVWR or GAWR including the blade and ballast. The rating label is found on the driver-side vehicle door cornerpost.

⚠ WARNING

To prevent accidental movement of the blade, always turn the control OFF whenever the snowplow is not in use. The power indicator light will turn OFF.

⚠ WARNING

Remove blade assembly before placing vehicle on hoist.

⚠ CAUTION

Refer to the eMatch tool for minimum vehicle recommendations and ballast requirements.

PERSONAL SAFETY

- Remove ignition key and put the vehicle in park or in gear to prevent others from starting the vehicle during installation or service.
- Wear only snug-fitting clothing while working on your vehicle or snowplow.
- Do not wear jewelry or a necktie, and secure long hair.
- Wear safety goggles to protect your eyes from battery acid, gasoline, dirt and dust.
- Avoid touching hot surfaces such as the engine, radiator, hoses and exhaust pipes.
- Always have a fire extinguisher rated BC handy, for flammable liquids and electrical fires.

FIRE AND EXPLOSION

⚠ WARNING

Gasoline is highly flammable and gasoline vapor is explosive. Never smoke while working on vehicle. Keep all open flames away from gasoline tank and lines. Wipe up any spilled gasoline immediately.

Be careful when using gasoline. Do not use gasoline to clean parts. Store only in approved containers away from sources of heat or flame.

CELL PHONES

A driver's first responsibility is the safe operation of the vehicle. The most important thing you can do to prevent a crash is to avoid distractions and pay attention to the road. Wait until it is safe to operate Mobile Communication Equipment such as cell phones, text messaging devices, pagers or two-way radios.

VENTILATION

⚠ WARNING

Vehicle exhaust contains lethal fumes. Breathing these fumes, even in low concentrations, can cause death. Never operate a vehicle in an enclosed area without venting exhaust to the outside.

NOISE

Airborne noise emission during use is below 70 dB(A) for the snowplow operator.









VIBRATION

Operating snowplow vibration does not exceed 2.5 m/s² to the hand-arm or 0.5 m/s² to the whole body.

TORQUE CHART

⚠ CAUTION

Read instructions before assembling. Fasteners should be finger tight until instructed to tighten according to the torque chart. Use standard methods and practices when attaching snowplow, including proper personal protective safety equipment.

Recommended Fastener Torque Chart					
Inch Fasteners Grade 5 and Grade 8					
Size	Torque (ft-lb)		Size	Torque (ft-lb)	
	 Grade 5	 Grade 8		 Grade 5	 Grade 8
1/4-20	8.4	11.9	9/16-12	109	154
1/4-28	9.7	13.7	9/16-18	121	171
5/16-18	17.4	24.6	5/8-11	150	212
5/16-24	19.2	27.3	5/8-18	170	240
3/8-16	30.8	43.6	3/4-10	269	376
3/8-24	35.0	49.4	3/4-16	297	420
7/16-14	49.4	69.8	7/8-9	429	606
7/16-20	55.2	77.9	7/8-14	474	669
1/2-13	75.3	106.4	1-8	644	909
1/2-20	85.0	120.0	1-12	704	995
Metric Fasteners Class 8.8 and 10.9					
Size	Torque (ft-lb)		Size	Torque (ft-lb)	
	 Class 8.8	 Class 10.9		 Class 8.8	 Class 10.9
M6 x 1.00	7.7	11.1	M20 x 2.50	325	450
M8 x 1.25	19.5	26.9	M22 x 2.50	428	613
M10 x 1.50	38.5	53.3	M24 x 3.00	562	778
M12 x 1.75	67	93	M27 x 3.00	796	1139
M14 x 2.00	107	148	M30 x 3.50	1117	1545
M16 x 2.00	167	231	M33 x 3.50	1468	2101
M18 x 2.50	222	318	M36 x 4.00	1952	2701
These torque values apply to fasteners except those noted in the instructions.					

INSTALLATION INSTRUCTIONS

NOTE: For easier assembly and installation, vehicle and all snowplow components should be on a smooth, level, hard surface, such as concrete.

VEHICLE PREPARATION

1. Remove plastic grille by pulling gently on the grille until the push clips release.
2. Remove the front bumper by removing the two cap screws from each side bracket and the four cap screws (two on each side) from beneath the grille. Retain the fasteners for reinstallation of the bumper.
3. If vehicle is equipped with tow hooks, remove both tow hooks. The tow hooks cannot be used with the mount installed. Retain tow hooks and fasteners for reinstallation if the snowplow is removed.
4. Remove the plastic air baffle from below the radiator. Retain fasteners for reinstallation of the air baffle.

MOUNT INSTALLATION



1. Align holes in the front of one pushplate with the existing holes at the front of the frame. Install the pushplate using two M12 x 110 mm cap screws, with M12 washers installed, through the pushplate and into the truck frame. Place an M12 flat washer and locknut onto each cap screw and hand tighten.
2. Push the rear support of the pushplate up against the bottom of the frame and align the rear hole with the existing hole in the bottom of the frame.
3. Using the large access hole in the side of the vehicle frame behind the pushplate, install the supplied flanged bolt with handle out through the existing hole in the frame and the rear hole of the pushplate. Place a 1/2" flat washer and locknut on the bolt and hand tighten.
4. Hold pushplate tight to the bottom of the frame using a floor jack and pushing it rearward as far as possible. Tighten all fasteners according to the torque chart provided in these instructions.
5. Using the hole in the side of the pushplate as a guide, drill a 17/32" hole into the side of the frame.
6. Using the square access hole in the outer side of the vehicle frame opposite the drilled hole, install the supplied bolt with short handle out through the drilled hole in the frame and the side hole of the pushplate. Place a 1/2" locknut on the bolt and tighten according to the torque chart.
7. Trim any portion of the handles protruding through the frame openings.
8. Repeat Steps 1 through 7 on the opposite side of the truck.

NOTE: After five to ten hours of snowplow usage, retorque all pushplate assembly fasteners.

AIR BAFFLE AND BUMPER REINSTALLATION

1. Reinstall air baffle with fasteners retained in Step 4 of Vehicle Preparation. If the vehicle is equipped with a one-piece air baffle/skid plate, notch the rear of the mounting tabs as shown in the illustration opposite.

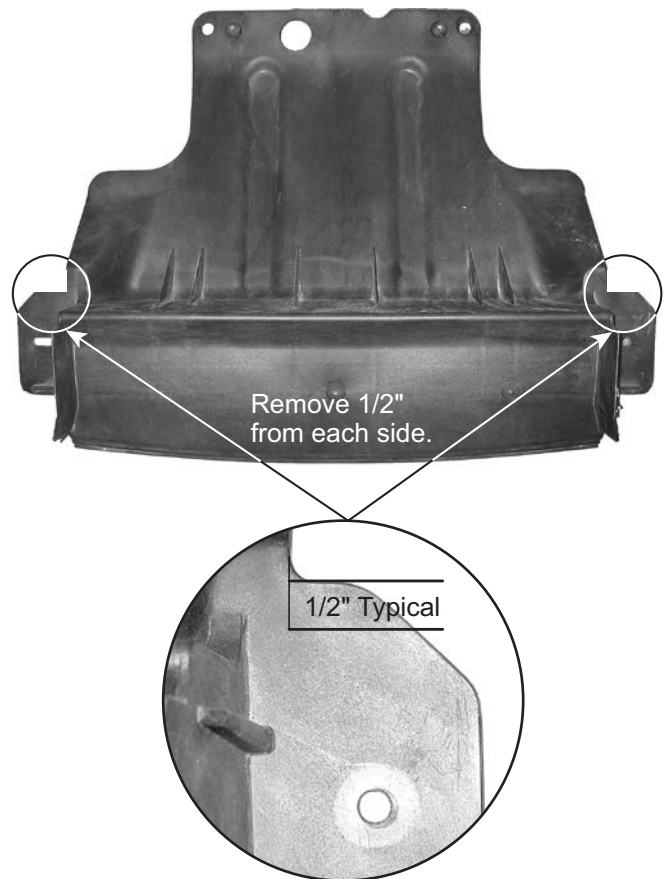

2. Remove the spoiler from the bottom of the air dam. The spoiler cannot be used with the mount installed.
3. Cut the air dam as shown below and remove entire section.
4. Reinstall the air dam and bumper with fasteners retained from Step 2 of Vehicle Preparation. Put the grille in position and press gently until the push clips engage.

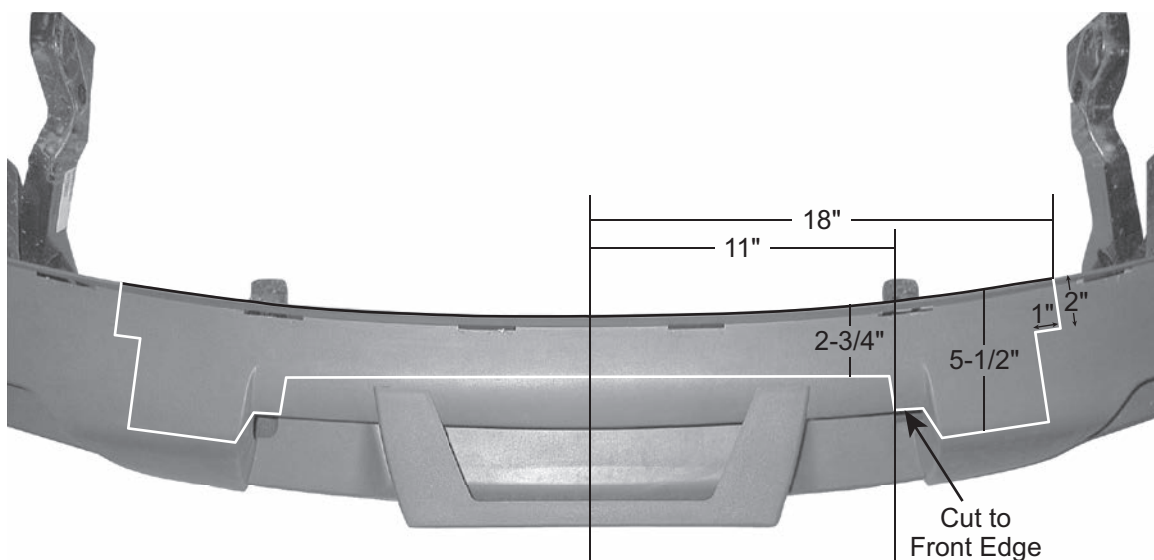



Fisher Engineering
50 Gordon Drive
Rockland, ME 04841-2139
www.fisherplows.com

A DIVISION OF FISHER, LLC

Fisher Engineering reserves the right under its product improvement policy to change construction or design details and furnish equipment when so altered without reference to illustrations or specifications used. Fisher Engineering or the vehicle manufacturer may require or recommend optional equipment for snow removal. Do not exceed vehicle ratings with a snowplow. Fisher Engineering offers a limited warranty for all snowplows and accessories. See separately printed page for this important information. The following are registered (®) or unregistered (™) trademarks of Douglas Dynamics, LLC: FISHER®, Minute Mount® 2, XLS™.

Printed in U.S.A.