

3713 TRUCK MOUNT

Installation Instructions for Personal Plow

Jeep Liberty

2003 – 20__

▲ CAUTION

Read this document before installing the snowplow.

▲ CAUTION

See your sales outlet for application recommendations. The Kit Selection Guide/ Selection List has specific vehicle and snowplow requirements.

SAFETY DEFINITIONS

⚠ WARNING

Indicates a potentially hazardous situation that, if not avoided, could result in death or serious personal injury.

⚠ CAUTION

Indicates a situation that, if not avoided, could result in damage to product or property.

NOTE: Identifies tips, helpful hints, and maintenance information the owner/operator should know.

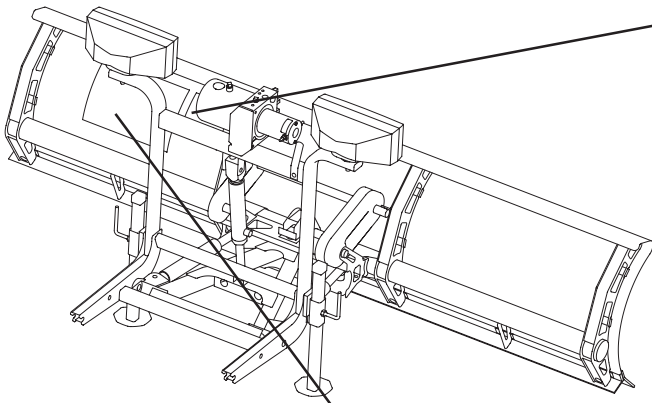

WARNING/CAUTION AND INSTRUCTION LABELS

Become familiar with and inform users about the warning label and instruction label on the back of the blade.

Warning and Caution Label

⚠ WARNING

LOWER BLADE WHEN VEHICLE IS PARKED.
 REMOVE BLADE ASSEMBLY BEFORE PLACING VEHICLE ON HOIST.
 DO NOT EXCEED GVWR OR GAWR INCLUDING BLADE AND BALLAST.

⚠ CAUTION

READ *OWNER'S MANUAL* BEFORE OPERATING OR SERVICING SNOWPLOW.
 TRANSPORT SPEED SHOULD NOT EXCEED 45 MPH. REDUCE SPEED UNDER ADVERSE TRAVEL CONDITIONS.
 PLOWING SPEED SHOULD NOT EXCEED 10 MPH.
 SEE YOUR SALES OUTLET FOR APPLICATION RECOMMENDATIONS.

Instruction Label

This snowplow is for personal/homeowner use only.

- ATTACH INSTRUCTIONS**
1. Make certain both **connecting pins** are fully retracted.
 2. Drive vehicle slowly to completely insert **attachment arms** into **receiver assembly slots**.
 3. Twist both **connecting pins** to release spring tension, then push **plow gear** toward vehicle so **connecting pins** fully engage holes in **attachment arms**.
 4. Loosen one **jack handle** and slide **jack sleeve** down below **jack retainer**. Remove **jack** and retighten **jack handle**. Repeat for other **jack** and store them.
 5. Connect all electrical cables from vehicle to snowplow.

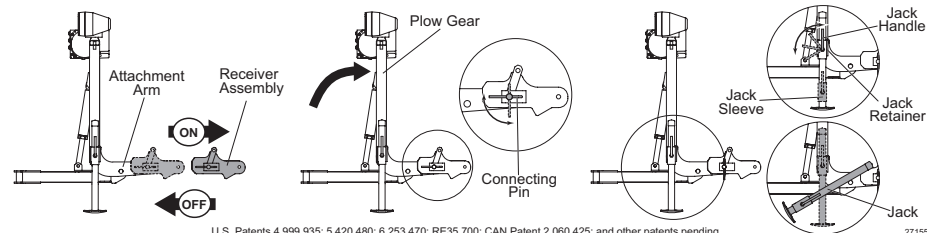

- DETACH INSTRUCTIONS**
5. Back vehicle away from snowplow.
 6. See Owner's Manual for proper snowplow storage.
 3. While pushing **plow gear** toward vehicle to release **connecting pin** tension, pull **connecting pin** out on one side and twist pin handle to keep pin retracted. Repeat procedure for other **connecting pin**.
 4. Disconnect all electrical cables.
 1. Put blade on ground using **LOWER/FLOAT** on snowplow control. Leave control **ON** and in **FLOAT**.
 2. Attach jacks. Loosen **jack handle**, put **jack** on ground, and raise **jack sleeve** until fully engaging **jack retainer**. Tighten **jack handle**. Repeat for other **jack**.

Read *Owner's Manual* for Complete Instructions

SAFETY PRECAUTIONS

Improper installation and operation could cause personal injury and/or equipment and property damage. Read and understand labels and the *Owner's Manual* before installing, operating, or making adjustments.

⚠ WARNING

Lower blade when vehicle is parked. Temperature changes could change hydraulic pressure, causing the blade to drop unexpectedly or damaging hydraulic components. Failure to do this can result in serious personal injury.

⚠ WARNING

Remove blade assembly before placing vehicle on hoist.

⚠ WARNING

The driver shall keep bystanders clear of the blade when it is being raised, lowered, or angled. Do not stand between the vehicle and the blade or within 8 feet of a moving blade. A moving or falling blade could cause personal injury.

⚠ WARNING

Keep hands and feet clear of the blade and A-frame when mounting or removing the snowplow. Moving or falling assemblies could cause personal injury.

⚠ WARNING

Do not exceed GVWR or GAWR including blade and ballast. The rating label is found on driver-side vehicle door cornerpost.

⚠ CAUTION

Refer to the Kit Selection Guide/Selection List for minimum vehicle recommendations and ballast requirements.

⚠ CAUTION

To prevent accidental movement of the blade, always turn the ON/OFF switch to OFF whenever the snowplow is not in use. The control indicator light will turn off.

PERSONAL SAFETY

- Wear only snug-fitting clothing while working on your vehicle or snowplow.
- Do not wear jewelry or a necktie, and secure long hair.
- Wear safety goggles to protect your eyes from battery acid, gasoline, dirt, and dust.
- Avoid touching hot surfaces such as the engine, radiator, hoses, and exhaust pipes.
- Always have a fire extinguisher rated BC handy, for flammable liquids and electrical fires.

FIRE AND EXPLOSION

⚠ WARNING

Gasoline is highly flammable and gasoline vapor is explosive. Never smoke while working on a vehicle. Keep all open flames away from gasoline tanks and lines. Wipe up any spilled gasoline immediately.

Be careful when using gasoline. Do not use gasoline to clean parts. Store only in approved containers away from sources of heat or flame.

VENTILATION



⚠ WARNING

Vehicle exhaust contains deadly carbon monoxide (CO) gas. Breathing this gas, even in low concentrations, could cause death. Never operate a vehicle in an enclosed area without venting exhaust to the outside.

TORQUE CHART

⚠ CAUTION

Read instructions before assembling. Fasteners should be finger tight until instructed to tighten according to the torque chart. Use standard methods and practices when attaching snowplow including wearing proper personal protective safety equipment.

Recommended Fastener Torque Chart (Ft.-Lb.)			
Size	 SAE Grade 2	 SAE Grade 5	 SAE Grade 8
1/4-20	6	9	13
5/16-18	11	18	28
3/8-16	19	31	46
3/8-24	24	46	68
7/16-14	30	50	75
1/2-13	45	75	115
9/16-12	66	110	165
5/8-11	93	150	225
3/4-10	150	250	370
7/8-9	150	378	591
1-8	220	583	893
Metric Grade 8.8 (Ft.-Lb.)			
Size	Torque	Size	Torque
M 6	7	M 12	60
M 8	17	M 14	95
M 10	35	M 16	155
These torque values apply to fasteners except those noted in the instruction.			

INSTALLATION INSTRUCTIONS

1. Remove the front bumper and air dam assembly. This will require the removal of the grille and a row of removable plastic snap fasteners beneath the grille. You will also need to drill the three lower pop rivets located between the wheel-well and the fender flaring on each side of the truck and the six pop-rivets underneath the bumper, as well as removing two screws in the radiator support. You will also find three clips between the fender flare and the end of the bumper on each side of the truck. Retain all of the reusable fasteners.
2. Remove the air dam from the bumper. This will require the removal of the pop rivet located in the center of the bumper.
3. Remove the two covers from the end of the frame rails and retain the fasteners.
4. On models with optional tow hooks, remove the tow hooks and all fasteners. Save these for reinstallation if mount is removed from vehicle.
5. On models with skid plate, remove the skid plate and cut the driver-side corner according to the photo below. After cutting reattach the skid plate to the vehicle.

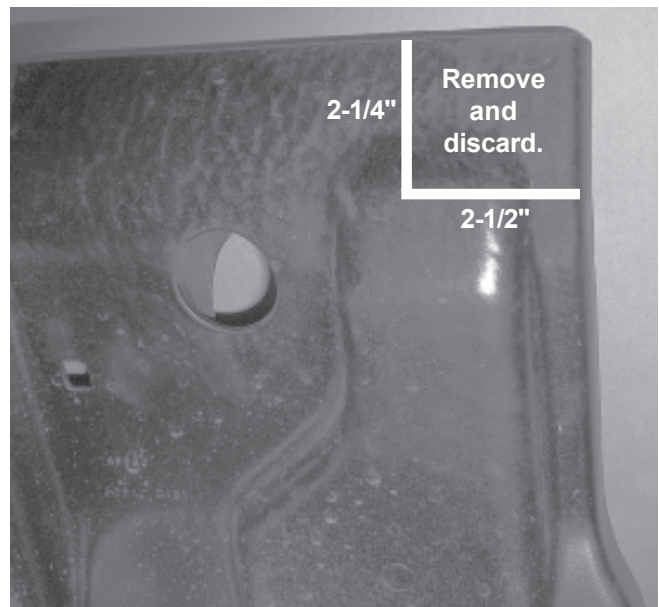

6. Place the mount against the front-end cross member and align the front holes of the mount with the holes in the bottom of the frame rails.
7. Place two 3/8-16 cap screws into a clamping plate and insert into the end of the frame rail. Drop the cap screws down through the holes in the frame and the holes in the mount. Place a 3/8" locknut onto each bolt, and hand tighten.

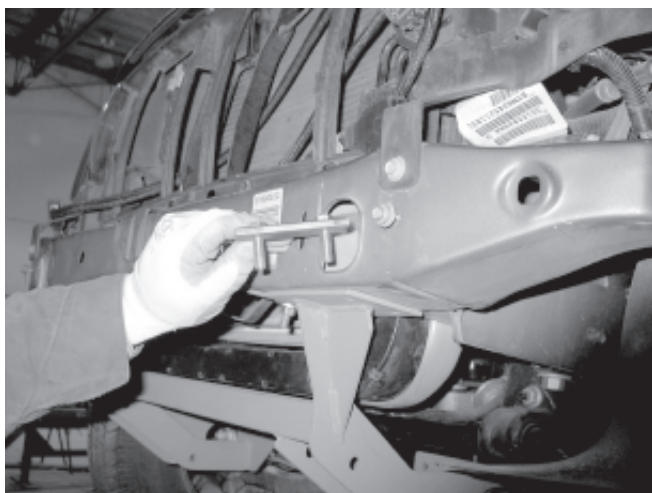

8. Insert a 3/8" flat washer through the square hole in the front cross member and position it over the round hole located just to the side of this. Bend a 3/8" bolt with handle as needed to insert it through the square hole and hook it down through the 3/8" flat washer, through the front cross member, and through the slot in the plow mount. Place a 3/8" flat washer and a 3/8" locknut on the bolt, and hand tighten.

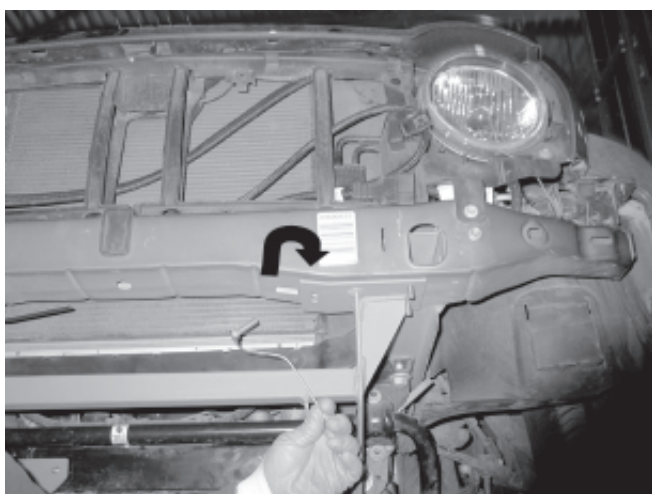

9. Repeat steps 7 and 8 on the opposite side of the truck. Tighten all fasteners to be snug but allow movement of the mount for positioning.
10. Verify that the vertical alignment of the rear of the mount is roughly centered over the front-end alignment bolt. Push the mount back until it is in contact with the front-end cross member and clamp the mount in place. This should allow for the offset washer to rotate freely about the bolt once the mount is installed.



11. Using the rear holes in the mount as guides, drill four 13/32" holes through the front-end cross member.
12. Place a 3/8" flat washer onto a 3/8" bolt with handle, and insert the bolt into the front-end cross member. Pass the bolt out through the drilled hole nearest the center of the truck and the hole in the rear of the mount. Place a 3/8" locknut on the bolt, and hand tighten.

⚠ CAUTION

A washer must not be used at the drilled hole nearest the outside of the truck due to an interference with vehicle suspension components.

13. Insert another 3/8" bolt with handle into the front-end cross member. Pass the bolt out through the drilled hole nearest the outside of the truck and the hole in the rear of the mount. Place a 3/8" locknut on the bolt, and hand tighten.

14. Repeat steps 12 and 13 on the opposite side of the truck. Rotate the ends of the handles up until they contact the frame prior to tightening.

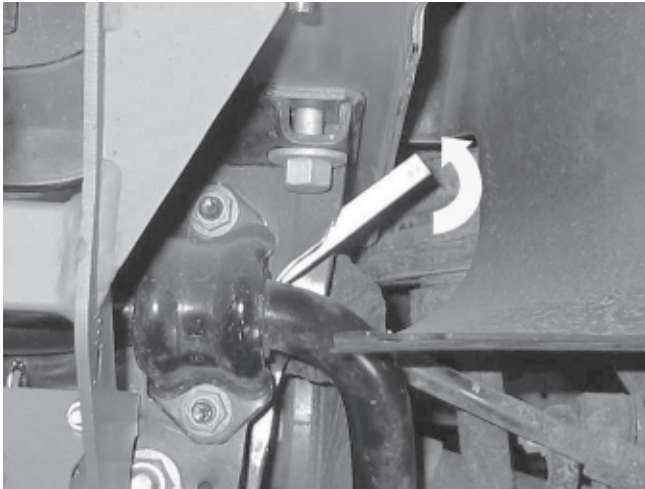

15. Tighten all fasteners to proper torque listed in the torque chart.
16. Bend or cut the ends of the bolt handles protruding out of the front cross member for appearance.
17. Reinstall the two covers over the ends of the frame rails.
18. It is suggested to run the wiring harness and cable prior to proceeding with these instructions. Once the wiring is in place leave the wires needed to splice into the vehicle park/turn signal wiring protruding out underneath the headlamps. These can be connected once the bumper has been refit to the vehicle.

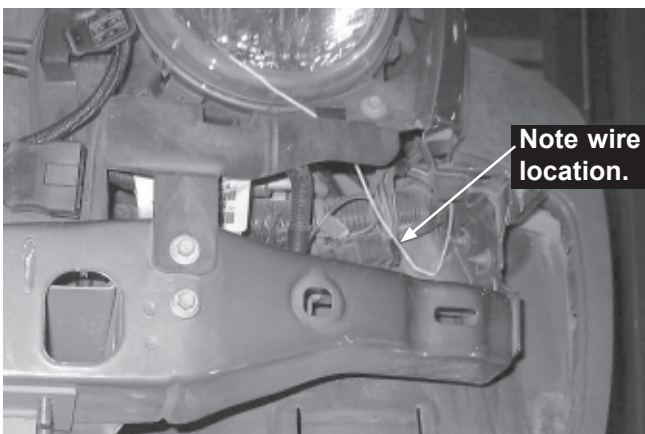

19. Using the hole in the center of the air dam as a guide, measure and cut two 4" wide pieces from the air dam as dimensioned and shown below. These dimensions are the same for the opposite side of the air dam. The two mounting holes are to be left intact as noted.

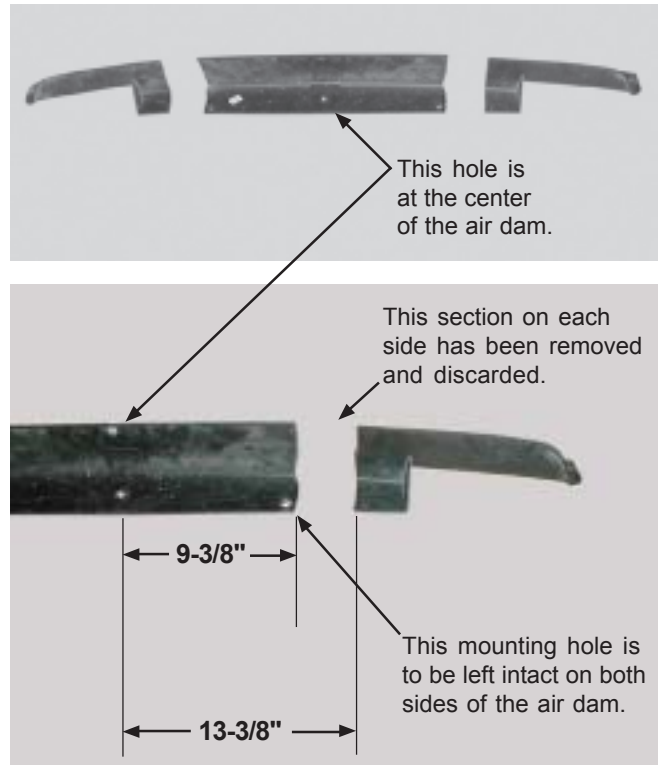

20. Using the hole in the center of the bumper as a guide, cut four slots in the bottom of the bumper to the dimensions shown below. These dimensions are the same for the opposite side of the bumper. The outer slots need to be 1/4" longer than the inner slots as shown and the two mounting holes are to be left intact as noted.

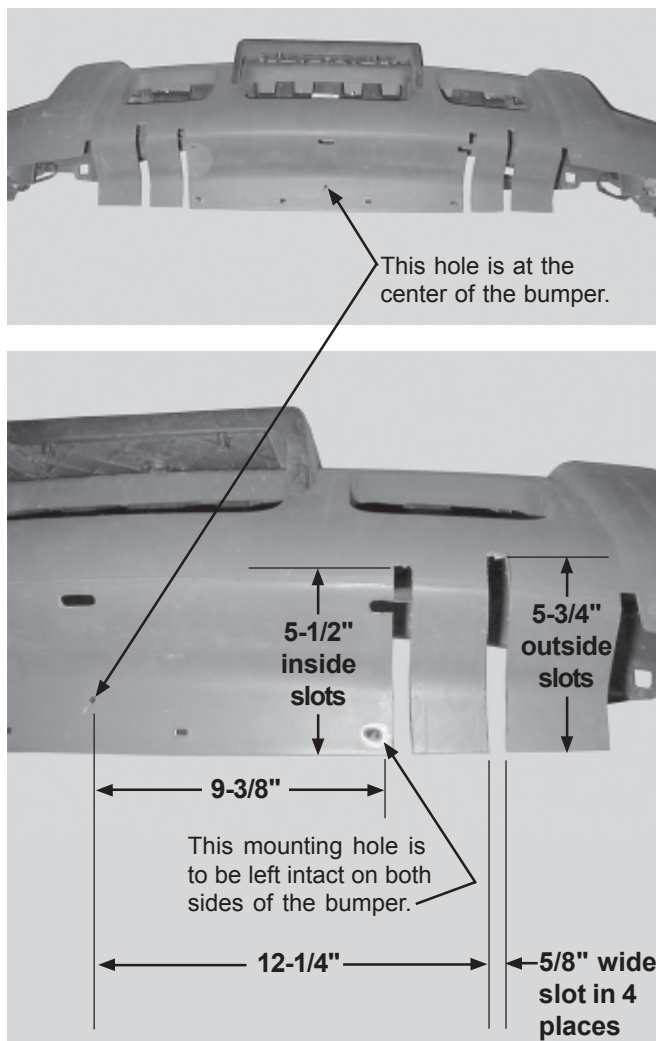

21. Reinstall the front bumper. The bumper wraps under the cross tube of the mount, and the slots in the bottom of the bumper fit around the side plates. The center section of the air dam is mounted with the bumper using the original fasteners.



NOTE: The plastic rivet manufacturer claims that "Under extremely dry conditions these rivets may break 'short' due to moisture loss. Should this occur, soak the rivets in water overnight.

22. The end pieces of the air dam are fastened to both the bumper and the plastic wheel-well using two plastic rivets as shown. This procedure requires the use of a Marson brand Klik-Loc™ plastic rivet setter number 48000 or equivalent, which is available from many local automotive centers or dealerships.

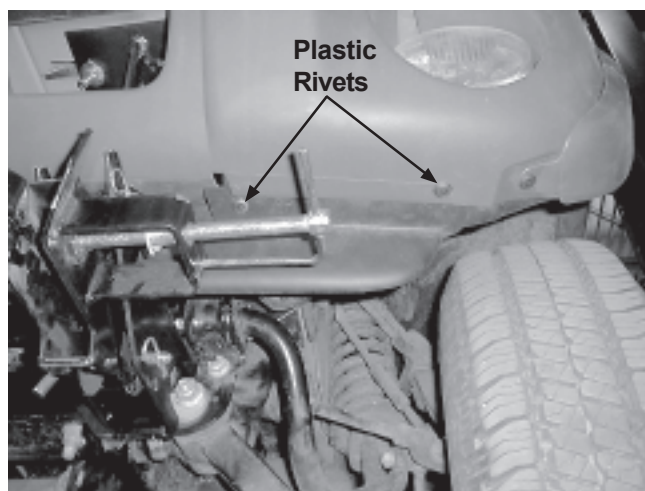

23. Reinstall the plastic rivets holding the fender flaring to both the bumper and the plastic wheel well.
24. Complete the installation of the wiring by splicing into the vehicle park/turn signal wiring per the electrical system installation instructions.

NOTE: After five to ten hours of snowplow usage, retorque all mount assembly fasteners.

The company reserves the right under its product improvement policy to change construction or design details and furnish equipment when so altered without reference to illustrations or specifications used. Do not exceed vehicle ratings with a snowplow. The company offers a limited warranty for all snowplows. See separately printed page for this important information.