

# 1233

## MOUNT KIT PERSONAL PLOW

Ford F-150 4X4

2004 - 08

### Installation Instructions

**⚠ CAUTION**

Read this document before installing the snowplow.

**⚠ CAUTION**

See your sales outlet/website for specific vehicle application recommendations before installation. The online selection system has specific vehicle and snowplow requirements.

**SAFETY DEFINITIONS**

**⚠ WARNING**  
 Indicates a potentially hazardous situation that, if not avoided, could result in death or serious personal injury.

**⚠ CAUTION**  
 Indicates a potentially hazardous situation that, if not avoided, may result in minor or moderate injury. It may also be used to alert against unsafe practices.







**NOTE:** Indicates a situation or action that can lead to damage to your snowplow and vehicle or other property. Other useful information can also be described.

**WARNING/CAUTION & INSTRUCTION LABELS**

Become familiar with and inform users about the warning and instruction labels on the back of the blade.

**NOTE:** If labels are missing or cannot be read, see your sales outlet.

Warning/Caution Label

<b>⚠ WARNING</b>	
	Lower blade when vehicle is parked.
	Do not exceed GVWR or GAWR including blade and ballast.
<b>⚠ CAUTION</b>	
	Read Owner's Manual before operating or servicing snowplow.
	Transport speed should not exceed 45 mph (72 km/h). Further reduce speed under adverse travel conditions.
	Plowing speed should not exceed 10 mph (16 km/h).
	See your sales outlet/Web site for specific vehicle application recommendations. 33990

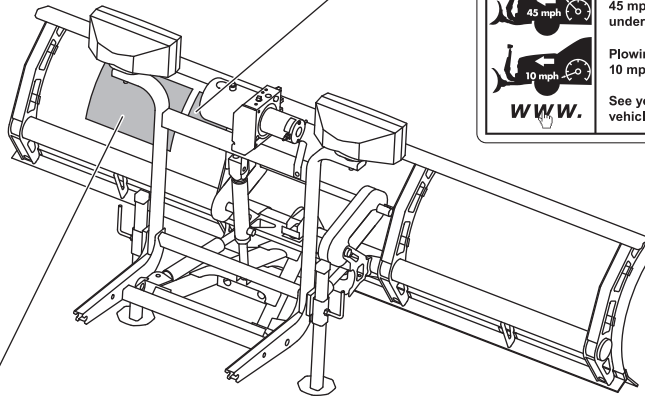

Instruction Label

***This snowplow is for personal/homeowner use only.***

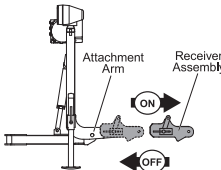
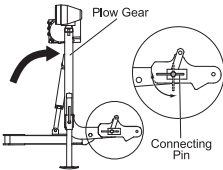
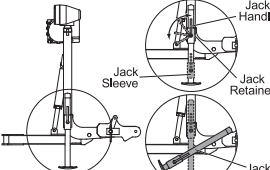
<b>ATTACH INSTRUCTIONS</b>	<ol style="list-style-type: none"> <li>1. Make certain both <b>connecting pins</b> are fully retracted.</li> <li>2. Drive vehicle slowly to completely insert <b>attachment arms</b> into <b>receiver assembly</b> slots.</li> <li>3. Twist both <b>connecting pins</b> to release spring tension, then push <b>plow gear</b> toward vehicle so <b>connecting pins</b> fully engage holes in <b>attachment arms</b>.</li> <li>4. Loosen one <b>jack handle</b> and slide <b>jack sleeve</b> down below <b>jack retainer</b>. Remove <b>jack</b> and retighten <b>jack handle</b>. Repeat for other <b>jack</b> and store them.</li> <li>5. Connect all electrical cables from vehicle to snowplow.</li> </ol>
	   <p style="font-size: small;">U.S. patents 6,941,685; 7,400,058; 7,737,576; and other patents pending.</p>
<b>DETACH INSTRUCTIONS</b>	<ol style="list-style-type: none"> <li>5. Back vehicle away from snowplow.</li> <li>6. See Owner's Manual for proper snowplow storage.</li> <li>3. While pushing <b>plow gear</b> toward vehicle to release <b>connecting pin</b> tension, pull <b>connecting pin</b> out on one side and twist pin handle to keep pin retracted. Repeat procedure for other <b>connecting pin</b>.</li> <li>4. Disconnect all electrical cables.</li> <li>1. Put blade on ground using <b>LOWER/FLOAT</b> on snowplow control. Leave control <b>ON</b> and in <b>FLOAT</b>.</li> <li>2. Attach <b>jacks</b>. Loosen <b>jack handle</b>, put <b>jack</b> on ground, and raise <b>jack sleeve</b> until fully engaging <b>jack retainer</b>. Tighten <b>jack handle</b>. Repeat for other <b>jack</b>.</li> </ol> <p style="font-size: small;">Read Owner's Manual for complete instructions.</p>

## SAFETY PRECAUTIONS

Improper installation and operation could cause personal injury and/or equipment and property damage. Read and understand labels and the Owner's Manual before installing, operating, or making adjustments.

### **⚠ WARNING**

**Lower the blade when vehicle is parked. Temperature changes could change hydraulic pressure, causing the blade to drop unexpectedly or damaging hydraulic components. Failure to do this could result in serious personal injury.**

### **⚠ WARNING**

**The driver shall keep bystanders clear of the blade when it is being raised, lowered, or angled. Do not stand between the vehicle and the blade or within 8 feet of a moving blade. A moving or falling blade could cause personal injury.**

### **⚠ WARNING**

**Keep hands and feet clear of the blade and A-frame when mounting or removing the snowplow. Moving or falling assemblies could cause personal injury.**

### **⚠ WARNING**

**Do not exceed GVWR or GAWR including the blade and ballast. The rating label is found on the driver-side vehicle door cornerpost.**

### **⚠ WARNING**

**To prevent accidental movement of the blade, always turn the control OFF whenever the snowplow is not in use. The power indicator light will turn OFF.**

### **⚠ WARNING**

**Remove blade assembly before placing vehicle on hoist.**

### **⚠ CAUTION**

**Refer to the online selection system for minimum vehicle recommendations and ballast requirements.**

## PERSONAL SAFETY

- Remove ignition key and put the vehicle in park or in gear to prevent others from starting the vehicle during installation or service.
- Wear only snug-fitting clothing while working on your vehicle or snowplow.
- Do not wear jewelry or a necktie, and secure long hair.
- Wear safety goggles to protect your eyes from battery acid, gasoline, dirt, and dust.
- Avoid touching hot surfaces such as the engine, radiator, hoses, and exhaust pipes.
- Always have a fire extinguisher rated BC handy, for flammable liquids and electrical fires.

## FIRE AND EXPLOSION

### **⚠ WARNING**

**Gasoline is highly flammable and gasoline vapor is explosive. Never smoke while working on vehicle. Keep all open flames away from gasoline tank and lines. Wipe up any spilled gasoline immediately.**

Be careful when using gasoline. Do not use gasoline to clean parts. Store only in approved containers away from sources of heat or flame.

## CELL PHONES

A driver's first responsibility is the safe operation of the vehicle. The most important thing you can do to prevent a crash is to avoid distractions and pay attention to the road. Wait until it is safe to operate Mobile Communication Equipment such as cell phones, text messaging devices, pagers, or two-way radios.

## VENTILATION

### **⚠ WARNING**

**Vehicle exhaust contains lethal fumes. Breathing these fumes, even in low concentrations, can cause death. Never operate a vehicle in an enclosed area without venting exhaust to the outside.**

**NOISE**

Airborne noise emission during use is below 70 dB(A) for the snowplow operator.









**VIBRATION**

Operating snowplow vibration does not exceed 2.5 m/s<sup>2</sup> to the hand-arm or 0.5 m/s<sup>2</sup> to the whole body.

**TORQUE CHART**

**⚠ CAUTION**

**Read instructions before assembling. Fasteners should be finger tight until instructed to tighten according to the torque chart. Use standard methods and practices when attaching snowplow, including proper personal protective safety equipment.**

<b>Recommended Fastener Torque Chart</b>					
<b>Inch Fasteners Grade 5 and Grade 8</b>					
Size	Torque (ft-lb)		Size	Torque (ft-lb)	
	 Grade 5	 Grade 8		 Grade 5	 Grade 8
1/4-20	8.4	11.9	9/16-12	109	154
1/4-28	9.7	13.7	9/16-18	121	171
5/16-18	17.4	24.6	5/8-11	150	212
5/16-24	19.2	27.3	5/8-18	170	240
3/8-16	30.8	43.6	3/4-10	269	376
3/8-24	35.0	49.4	3/4-16	297	420
7/16-14	49.4	69.8	7/8-9	429	606
7/16-20	55.2	77.9	7/8-14	474	669
1/2-13	75.3	106.4	1-8	644	909
1/2-20	85.0	120.0	1-12	704	995
<b>Metric Fasteners Class 8.8 and 10.9</b>					
Size	Torque (ft-lb)		Size	Torque (ft-lb)	
	 Class 8.8	 Class 10.9		 Class 8.8	 Class 10.9
M6 x 1.00	7.7	11.1	M20 x 2.50	325	450
M8 x 1.25	19.5	26.9	M22 x 2.50	428	613
M10 x 1.50	38.5	53.3	M24 x 3.00	562	778
M12 x 1.75	67	93	M27 x 3.00	796	1139
M14 x 2.00	107	148	M30 x 3.50	1117	1545
M16 x 2.00	167	231	M33 x 3.50	1468	2101
M18 x 2.50	222	318	M36 x 4.00	1952	2701
These torque values apply to fasteners except those noted in the instructions.					

**INSTALLATION INSTRUCTIONS**

**NOTE: For easier assembly and installation, vehicle and all snowplow components should be on a smooth, level, hard surface, such as concrete.**

1. Detach the rubber splash shield at the bottom edge of the bumper by removing the three plastic fasteners. From the top surface of the bumper, remove the four metric cap screws that attach the plastic trim, hood-release handle, and grille bumper. Also, remove the hood-release cable support. Retain the plastic fasteners and metric cap screws.
2. Remove both tow hooks from the front of the frame, and retain the fasteners. The tow hooks cannot be used with the mount installed. Retain the tow hooks for reinstallation if the snowplow is removed.
3. If necessary, remove the skid plate, and save the parts for reinstallation if the mount is removed from the vehicle.
4. Disconnect the fog lamp harness connections if so equipped.
5. Remove and save the four nuts (two on each side of vehicle) from the back surface of the bumper brackets. Slide the bumper forward to remove.
6. Position the mount under the vehicle frame. Line up the slotted holes in the mount with the tow hook holes in the frame. Reusing the tow hook fasteners, install the mount to the bottom of the frame, and tighten fasteners according to the torque chart.

**⚠ CAUTION**

Before drilling holes, check to be sure that no vehicle wiring or other components could be damaged.

- Using the four holes in the mount as guides, drill four 17/32" holes in the vehicle frame.

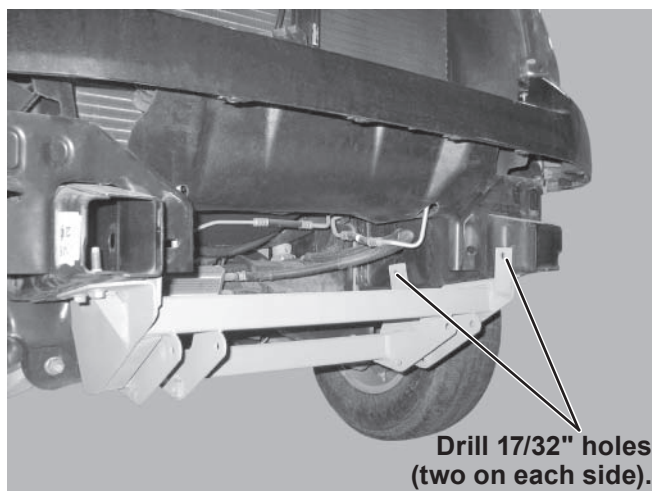

- Place a 1/2" washer onto a 1/2" x 1-1/4" cap screw with handle, and insert the cap screw into the truck frame. Pass the cap screw out through the hole in the truck frame and the hole in the rear tab of the mount. Place a 1/2" locknut on the cap screw and hand tighten.

Repeat on the other side.

- Insert a 1/2" x 1-1/2" cap screw through each front mount tab and into the frame. Place a 1/2" washer and 1/2" locknut on the cap screws inside the frame. The locknuts must be placed inside the frame; otherwise, the bumper will not reattach. Tighten all four mount tab fasteners according to the torque chart.
- Reinstall the bumper to its original position using the existing fasteners.
- Reconnect the fog lamp harness connectors if so equipped.
- Reattach the rubber splash shield at the bottom edge of bumper using the original plastic fasteners. At top surface of the bumper, reinstall the four metric cap screws, plastic trim, hood-release handle, and grille bumper. Reinstall the hood-release cable support.

---

**NOTE: After five to ten hours of snowplow usage, retorque all mount assembly fasteners.**

---

The company reserves the right under its product improvement policy to change construction or design details and furnish equipment when so altered without reference to illustrations or specifications used. This equipment manufacturer or the vehicle manufacturer may require or recommend optional equipment for snow removal. Do not exceed vehicle ratings with a snowplow. The company offers a limited warranty for all snowplows and accessories. See separately printed page for this important information.

**Printed in U.S.A.**

---