

# 31554-1

## MOUNT KIT COMPACT PLOW

**GM K1500 Silverado/Sierra**

**Mid-Year Refresh\***

**2022 (Mid)–\_\_**

**GM K1500 Silverado/Sierra**

**2019–2022 (Mid)**

**Tahoe/Yukon**

**2021–\_\_**

### Installation Instructions

**⚠ CAUTION**

Read this document before installing the snowplow.

**⚠ CAUTION**

See your sales outlet/website for specific vehicle application recommendations before installation. The online selection system has specific vehicle and snowplow requirements.

\* 2022 Mid-Year Refresh models contain the number zero (0) as the second numeral in the model number (refer to glove box or door frame for model number). For example, model K10973 is a 2022 Mid-Year Refresh model, whereas K18973 is a 2022 LTD model.

**SAFETY DEFINITIONS**

**⚠ WARNING**

Indicates a potentially hazardous situation that, if not avoided, could result in death or serious personal injury.

**⚠ CAUTION**

Indicates a potentially hazardous situation that, if not avoided, may result in minor or moderate injury. It may also be used to alert against unsafe practices.

**NOTE:** Indicates a situation or action that can lead to damage to your snowplow and vehicle or other property. Other useful information can also be described.

**WARNING/CAUTION & INSTRUCTION LABELS**

Become familiar with and inform users about the warning and instruction labels on the back of the blade.

**NOTE:** If labels are missing or cannot be read, see your sales outlet.

**Instruction Label**

<p><b>ATTACH</b></p> <ol style="list-style-type: none"> <li>1. Verify both connecting pins are pulled out and locked into the receiver notch.</li> <li>2. Slowly drive vehicle forward to engage rear receiver pins completely into headgear slots. Apply vehicle parking brake.</li> <li>3. Rotate and unlock connecting pins on receivers.</li> <li>4. Plug in electrical harness.</li> <li>5. Turn plow control in vehicle ON and activate FLOAT.</li> <li>6. Stand in front of blade. Push top of headgear toward vehicle to allow connecting pins to fully engage connecting pin holes.</li> <li>7. Verify that both connecting pins are engaged through all holes on the headgear and receivers.</li> <li>8. While holding stand lock pin out, use stand handle to raise stand. Release stand lock pin into locking hole and verify stand is secure.</li> </ol> <p><b>DETACH</b></p> <ol style="list-style-type: none"> <li>1. With blade straight, lower snowplow to the ground. Activate FLOAT, then turn plow control in vehicle OFF. Apply vehicle parking brake.</li> <li>2. Unplug electrical harness.</li> <li>3. Pull stand lock pin out and let stand drop to the ground. Release the stand lock pin. Verify that stand is locked by trying to lift stand.</li> <li>4. Pull both connecting pins out and rotate to lock into the receiver notch.</li> </ol>	<p><b>⚠ WARNING</b> Keep fingers away from snowplow and vehicle attachment points.</p> <p>ATTACH – Steps 1, 2, 3, 6, 7, &amp; 8 DETACH – Steps 3 &amp; 4</p> <p>US patents 7,400,058; 7,737,576; and other patents pending. Read Owner's Manual for complete instructions.</p>
--	--

**Warning/Caution Label**

<p><b>⚠ WARNING</b></p>	<p>Blade could drop unexpectedly, crushing or trapping limbs. Lower blade when vehicle is parked.</p> <p>Overloading could negatively affect vehicle handling. To avoid serious injury or death, do not exceed GVWR or GAWR including blade and ballast.</p>
<p><b>⚠ CAUTION</b></p>	<p>Read Owner's Manual before operating or servicing snowplow.</p> <p>Transport speed should not exceed 45 mph (72 km/h). Further reduce speed under adverse travel conditions.</p>
	<p>Plowing speed should not exceed 10 mph (16 km/h).</p> <p>See your sales outlet/website for specific vehicle application recommendations.</p>

**Warning Label**

**⚠ WARNING**

**Crush hazard**

Keep feet clear

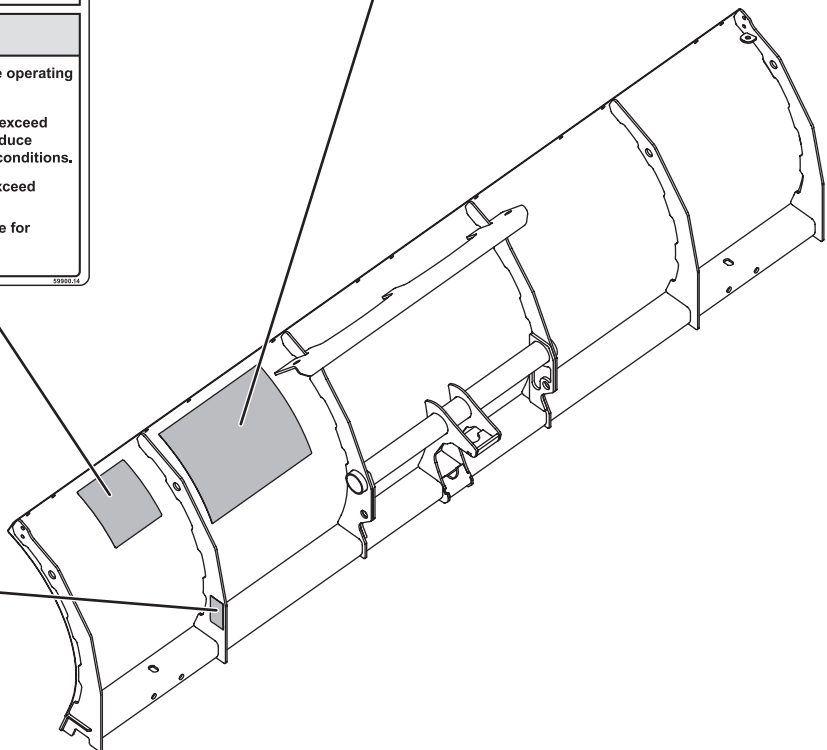

## SAFETY PRECAUTIONS

Improper installation and operation could cause personal injury and/or equipment and property damage. Read and understand labels and the Owner's Manual before installing, operating, or making adjustments.

### **⚠ WARNING**

**Lower the blade when vehicle is parked. Temperature changes could change hydraulic pressure, causing the blade to drop unexpectedly or damaging hydraulic components. Failure to do this could result in serious personal injury.**

### **⚠ WARNING**

**The driver shall keep bystanders clear of the blade when it is being raised, lowered, or angled. Do not stand between vehicle and blade or within 8 feet of a moving blade. A moving or falling blade could cause personal injury.**

### **⚠ WARNING**

**Keep hands and feet clear of the blade and A-frame when mounting or removing the snowplow. Moving or falling assemblies could cause personal injury.**

### **⚠ WARNING**

**Do not exceed GVWR or GAWR including the blade and ballast. The rating label is found on the driver-side vehicle door cornerpost.**

### **⚠ WARNING**

**To prevent accidental movement of the blade, always turn the control OFF whenever the snowplow is not in use. The power indicator light will turn OFF.**

### **⚠ WARNING**

**Remove blade assembly before placing vehicle on hoist.**

### **⚠ CAUTION**

**Refer to the online selection system for minimum vehicle recommendations and ballast requirements.**

## PERSONAL SAFETY

- Remove the ignition key and put the vehicle in PARK or in gear to prevent others from starting the vehicle during installation or service.
- Wear only snug-fitting clothing while working on your vehicle or snowplow.
- Do not wear jewelry or a necktie, and secure long hair.
- Wear safety goggles to protect your eyes from battery acid, gasoline, dirt, and dust.
- Avoid touching hot surfaces such as the engine, radiator, hoses, and exhaust pipes.
- Always have a fire extinguisher rated BC handy, for flammable liquids and electrical fires.

## FIRE AND EXPLOSION

### **⚠ WARNING**

**Gasoline is highly flammable and gasoline vapor is explosive. Never smoke while working on vehicle. Keep all open flames away from gasoline tank and lines. Wipe up any spilled gasoline immediately.**

Be careful when using gasoline. Do not use gasoline to clean parts. Store only in approved containers away from sources of heat or flame.

## CELL PHONES

A driver's first responsibility is the safe operation of the vehicle. The most important thing you can do to prevent a crash is to avoid distractions and pay attention to the road. Wait until it is safe to operate mobile communication equipment such as cell phones, text messaging devices, pagers, or two-way radios.

## VENTILATION

### **⚠ WARNING**

**Vehicle exhaust contains lethal fumes. Breathing these fumes, even in low concentrations, can cause death. Never operate a vehicle in an enclosed area without venting exhaust to the outside.**

**NOISE**

Airborne noise emission during use is below 70 dB(A) for the snowplow operator.

**VIBRATION**

Operating snowplow vibration does not exceed 2.5 m/s<sup>2</sup> to the hand-arm or 0.5 m/s<sup>2</sup> to the whole body.

**TORQUE CHART**

**⚠ CAUTION**

**Read instructions before assembling. Fasteners should be finger tight until instructed to tighten according to the torque chart. Use standard methods and practices when attaching snowplow, including proper personal protective safety equipment.**

Recommended Fastener Torque Chart					
Inch Fasteners Grade 5 and Grade 8					
Size	Torque (ft-lb)		Size	Torque (ft-lb)	
	Grade 5	Grade 8		Grade 5	Grade 8
1/4-20	8.4	11.9	9/16-12	109	154
1/4-28	9.7	13.7	9/16-18	121	171
5/16-18	17.4	24.6	5/8-11	150	212
5/16-24	19.2	27.3	5/8-18	170	240
3/8-16	30.8	43.6	3/4-10	269	376
3/8-24	35.0	49.4	3/4-16	297	420
7/16-14	49.4	69.8	7/8-9	429	606
7/16-20	55.2	77.9	7/8-14	474	669
1/2-13	75.3	106.4	1-8	644	909
1/2-20	85.0	120.0	1-12	704	995

Metric Fasteners Class 8.8 and 10.9					
Size	Torque (ft-lb)		Size	Torque (ft-lb)	
	Class 8.8	Class 10.9		Class 8.8	Class 10.9
M6 x 1.00	7.7	11.1	M20 x 2.50	325	450
M8 x 1.25	19.5	26.9	M22 x 2.50	428	613
M10 x 1.50	38.5	53.3	M24 x 3.00	562	778
M12 x 1.75	67	93	M27 x 3.00	796	1139
M14 x 2.00	107	148	M30 x 3.50	1117	1545
M16 x 2.00	167	231	M33 x 3.50	1468	2101
M18 x 2.50	222	318	M36 x 4.00	1952	2701

These torque values apply to fasteners except those noted in the instructions.

**INSTALLATION INSTRUCTIONS**

**NOTE: For easier assembly and installation, the vehicle and all snowplow components should be on a smooth, level, hard surface, such as concrete.**

1. Remove the bumper and tow hooks, if equipped, from the vehicle. Save the tow hooks and fasteners for reinstallation.

**NOTE: Tow hooks cannot be reinstalled with the mount in place on 2022 Mid-Year Refresh models.**

2. For models equipped with tow hooks (those manufactured *before* the 2022 Mid-Year Refresh): Place the passenger-side mount against the outside of the passenger-side frame rail. Reinstall the tow hook fasteners through the mount and tow hook. Hand tighten the fasteners.

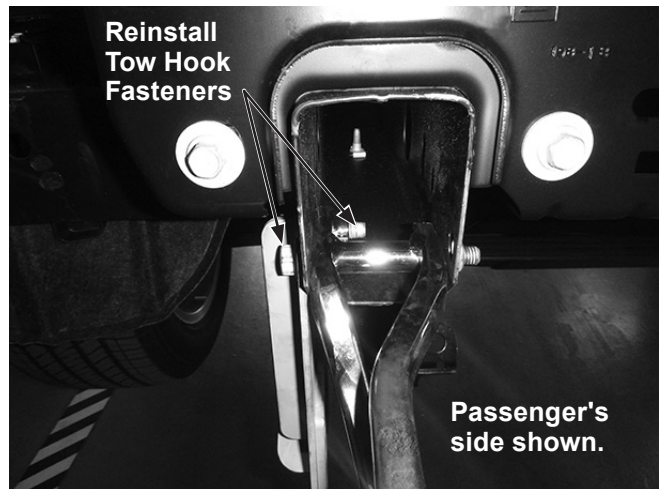
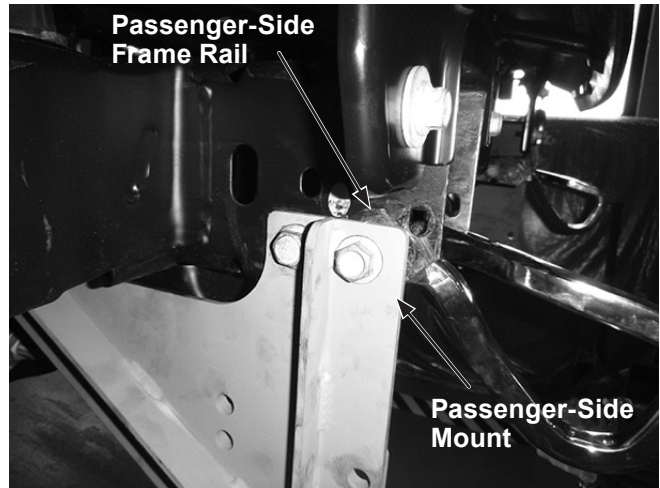

**For models not equipped with tow hooks (2022 Mid-Year Refresh models):** Place the passenger-side mount against the outside of the passenger-side frame rail, lining up the mounting holes with the corresponding holes in frame as shown. Install 1/2" x 1-1/2" cap screws through the mount and frame. Secure with 1/2" washers and 1/2" locknuts. Hand tighten the fasteners.

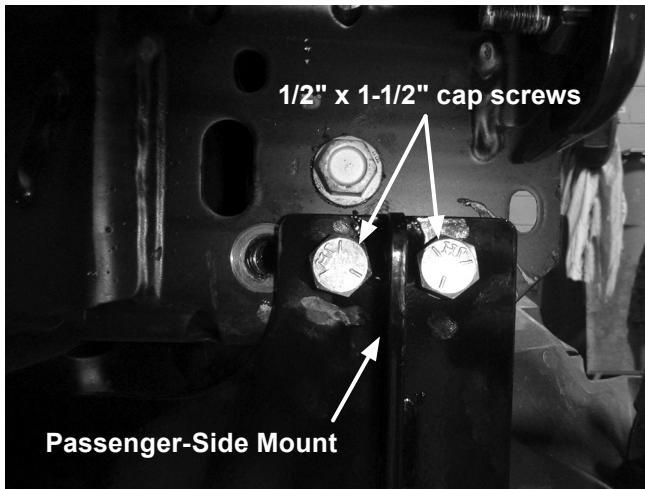

**⚠ CAUTION**

**Before drilling any holes, check to be sure that no vehicle wiring or other components could be damaged.**

3. **All models:** Check that the rear of the mount is pushed up against the bottom of the frame. Using the mount as a guide, drill a 17/32" hole through the frame. Insert a 1/2" x 1-1/2" handled cap screw through the drilled hole. Secure with a 1/2" washer and 1/2" locknut. Hand tighten.





4. **For models equipped with tow hooks (those manufactured *before* the 2022 Mid-Year Refresh):** Place the driver-side mount against the outside of the driver-side frame rail. Reinstall the front tow hook fastener through the mount and tow hook. Reinstall the rear tow hook fastener. Hand tighten.

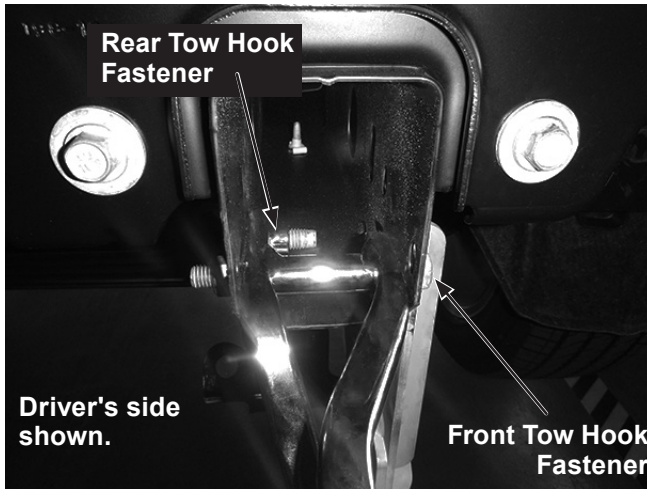

**For models not equipped with tow hooks (2022 Mid-Year Refresh models):** Place the driver-side mount against the outside of the driver-side frame rail. Install a 1/2" x 1-1/2" cap screw through the front hole of the mount. Secure with a 1/2" washer and 1/2" locknut. Hand tighten.

**⚠ CAUTION**

**Use caution not to pinch, cut, or drill through any wires or hoses running along the frame rail.**

5. **All models:** Check that the rear of the mount is pushed up against the frame. Use the mount as a guide to drill a 17/32" hole in the location shown. Install a 1/2" x 1-1/2" fastener through the hole, and secure with a 1/2" washer and 1/2" locknut. Hand tighten.

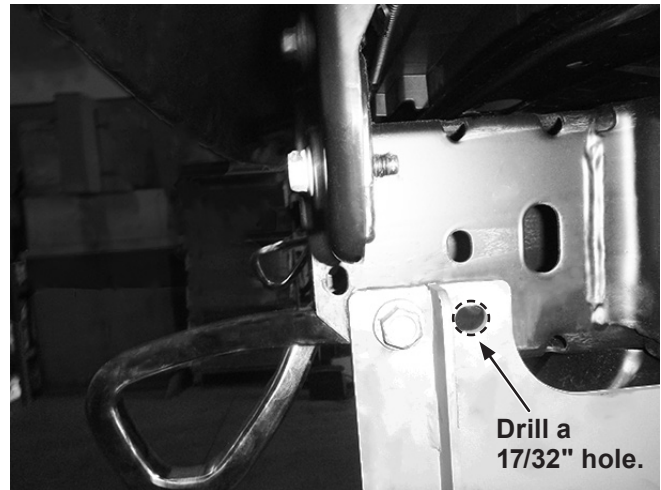

6. Repeat Steps 3–5 on the driver's side of the vehicle.

7. Install the mount beam using eight 1/2" x 1-1/2" cap screws (four on each side). Use the set of holes that positions the mount beam closest to 10-1/4" from the ground when measured as shown below.

**NOTE:** For vehicles equipped with 2.7 L Turbo, 3.0 L Diesel, or the Max Trailering Package, install the mount beam in the lowest set of holes possible to allow clearance for the auxiliary air duct.



Ensure that the distance from the ground to the center of the lower hole on the beam is 10-1/4" ± 1".

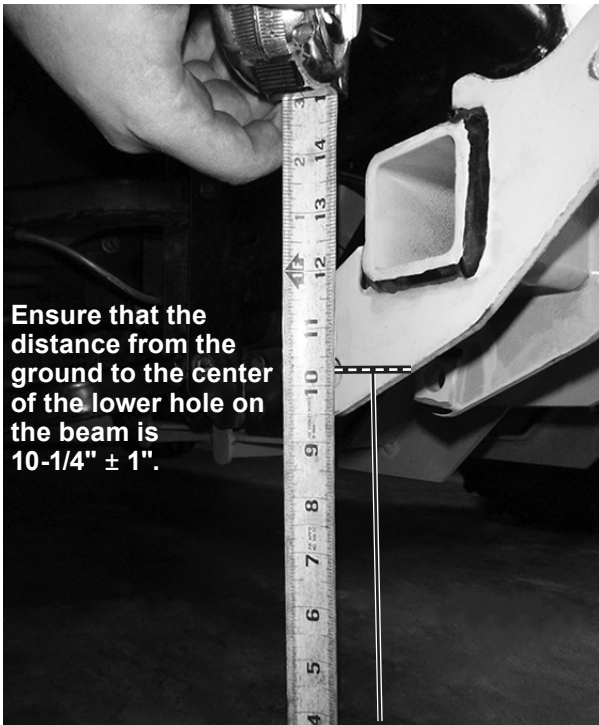

8. Secure the mount beam with 1/2" locknuts. Hand tighten the fasteners.

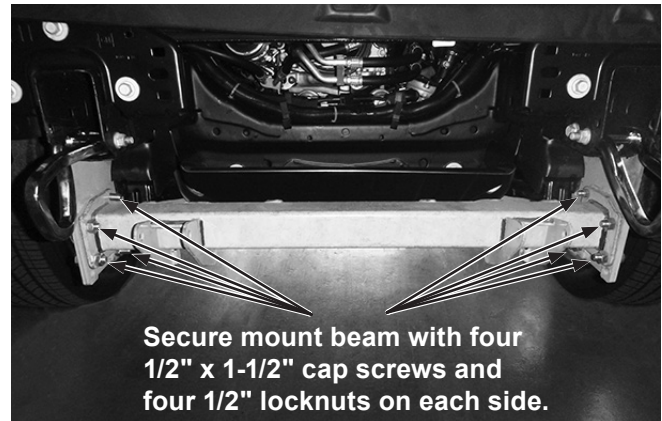

9. Tighten all fasteners according to the torque chart.
10. Measure the distance between the mount beam rear hole and the ground. If it exceeds 11-1/2", install the accessory Height Adapter Plate Kit (PN 77555) to ensure optimum plowing performance.
11. Reinstall the bumper. Trim the bumper as necessary to allow mount clearance.

**For Tahoe/Yukon models:** Secure the front fascia to the mount beam using the supplied cable ties.

**NOTE:** After five to ten hours of snowplow usage, retorque all mount assembly fasteners.

The company reserves the right under its product improvement policy to change construction or design details and furnish equipment when so altered without reference to illustrations or specifications used. This equipment manufacturer or the vehicle manufacturer may require or recommend optional equipment for snow removal. Do not exceed vehicle ratings with a snowplow. The company offers a limited warranty for all snowplows and accessories. See separately printed page for this important information.

**Printed in U.S.A.**

---