

35146

MOUNT KIT

Kawasaki Mule Pro FX, FXT
Kawasaki Mule Pro FXR

2014—__
2018—__

Installation Instructions

▲ CAUTION

Read this document before installing the snowplow.

▲ CAUTION

See your sales outlet/website for specific vehicle application recommendations before installation. The online selection system has specific vehicle and snowplow requirements.

SAFETY DEFINITIONS

⚠ WARNING

Indicates a potentially hazardous situation that, if not avoided, could result in death or serious personal injury.

⚠ CAUTION

Indicates a potentially hazardous situation that, if not avoided, may result in minor or moderate injury. It may also be used to alert against unsafe practices.

NOTE: Indicates a situation or action that can lead to damage to your snowplow and vehicle or other property. Other useful information can also be described.

WARNING/CAUTION & INSTRUCTION LABELS

Become familiar with and inform users about the warning and instruction labels on the back of the blade.

NOTE: If labels are missing or cannot be read, see your sales outlet.

Attach/Detach Label

<p>ATTACH</p> <ol style="list-style-type: none"> Slowly drive vehicle forward to engage rear receiver pins into headgear slots. Apply vehicle parking brake. Hold down lock lever and move hitch pin handle out of the handle lock notch, allowing spring to move the hitch pin handle forward. Plug in electrical harness. Turn plow control in vehicle ON and activate FLOAT. Stand in front of blade. Push top of headgear toward vehicle to allow hitch pins to fully engage hitch pin holes. Verify the lock pin is engaged in the forward hole in the lock pin bracket. Remove hairpin, adjustment pin, & stand. 	<p>⚠ WARNING Keep fingers away from snowplow and UTV attachment points.</p>
<p>DETACH</p> <ol style="list-style-type: none"> With blade straight, lower snowplow to the ground. Activate FLOAT, then turn plow control in vehicle OFF. Apply vehicle parking brake. Unplug electrical harness. Insert stand through slot in the passenger side headgear horn. Adjust stand as far down as possible, install adjustment pin, and secure with a hairpin. Hold down lock lever to disengage the lock pin and move the hitch pin handle rearward to fully disengage hitch pins from receivers. Move hitch pin handle into handle lock notch. 	<p>US patents 7,400,056; 7,737,576; 9,200,418. 0833142</p> <p>Read Owner's Manual for complete instructions.</p>

Warning/Caution Label

<p>⚠ WARNING</p>	<p>Lower blade when vehicle is parked.</p>
	<p>Do not exceed GVWR or GAWR including blade and ballast.</p>
<p>⚠ CAUTION</p>	<p>Read Owner's Manual before operating or servicing snowplow.</p> <p>Transport speed should not exceed 20 mph (32 km/h). Further reduce speed under adverse travel conditions.</p> <p>Plowing speed should not exceed 10 mph (16 km/h).</p> <p>See your sales outlet/website for specific vehicle application recommendations.</p>

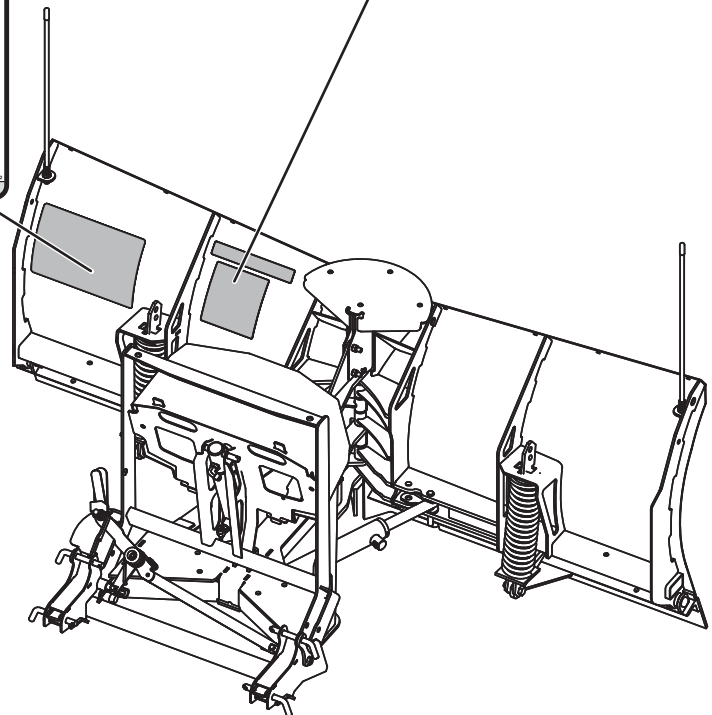

SAFETY PRECAUTIONS

Improper installation and operation could cause personal injury and/or equipment and property damage. Read and understand labels and the Owner's Manual before installing, operating, or making adjustments.

⚠ WARNING

Lower the blade when vehicle is parked. Temperature changes could change hydraulic pressure, causing the blade to drop unexpectedly or damaging hydraulic components. Failure to do this could result in serious personal injury.

⚠ WARNING

The driver shall keep bystanders clear of the blade when it is being raised, lowered, or angled. Do not stand between the vehicle and the blade or within 8 feet of a moving blade. A moving or falling blade could cause personal injury.

⚠ WARNING

Keep hands and feet clear of the blade and A-frame when mounting or removing the snowplow. Moving or falling assemblies could cause personal injury.

⚠ WARNING

Do not exceed GVWR or GAWR including the blade and ballast. The rating label is found on the driver-side vehicle door cornerpost.

⚠ WARNING

To prevent accidental movement of the blade, always turn the control OFF whenever the snowplow is not in use. The power indicator light will turn OFF.

⚠ WARNING

Remove blade assembly before placing vehicle on hoist.

⚠ CAUTION

Refer to the online selection system for minimum vehicle recommendations and ballast requirements.

PERSONAL SAFETY

- Remove the ignition key and put the vehicle in PARK or in gear to prevent others from starting the vehicle during installation or service.
- Wear only snug-fitting clothing while working on your vehicle or snowplow.
- Do not wear jewelry or a necktie, and secure long hair.
- Wear safety goggles to protect your eyes from battery acid, gasoline, dirt, and dust.
- Avoid touching hot surfaces such as the engine, radiator, hoses, and exhaust pipes.
- Always have a fire extinguisher rated BC handy, for flammable liquids and electrical fires.

FIRE AND EXPLOSION

⚠ WARNING

Gasoline is highly flammable and gasoline vapor is explosive. Never smoke while working on vehicle. Keep all open flames away from gasoline tank and lines. Wipe up any spilled gasoline immediately.

Be careful when using gasoline. Do not use gasoline to clean parts. Store only in approved containers away from sources of heat or flame.

CELL PHONES

A driver's first responsibility is the safe operation of the vehicle. The most important thing you can do to prevent a crash is to avoid distractions and pay attention to the road. Wait until it is safe to operate Mobile Communication Equipment such as cell phones, text messaging devices, pagers, or two-way radios.

VENTILATION

⚠ WARNING

Vehicle exhaust contains lethal fumes. Breathing these fumes, even in low concentrations, can cause death. Never operate a vehicle in an enclosed area without venting exhaust to the outside.

NOISE

Airborne noise emission during use is below 70 dB(A) for the snowplow operator.









VIBRATION

Operating snowplow vibration does not exceed 2.5 m/s² to the hand-arm or 0.5 m/s² to the whole body.

TORQUE CHART

⚠ CAUTION

Read instructions before assembling. Fasteners should be finger tight until instructed to tighten according to the torque chart. Use standard methods and practices when attaching snowplow, including proper personal protective safety equipment.

Recommended Fastener Torque Chart					
Inch Fasteners Grade 5 and Grade 8					
Size	Torque (ft-lb)		Size	Torque (ft-lb)	
	 Grade 5	 Grade 8		 Grade 5	 Grade 8
1/4-20	8.4	11.9	9/16-12	109	154
1/4-28	9.7	13.7	9/16-18	121	171
5/16-18	17.4	24.6	5/8-11	150	212
5/16-24	19.2	27.3	5/8-18	170	240
3/8-16	30.8	43.6	3/4-10	269	376
3/8-24	35.0	49.4	3/4-16	297	420
7/16-14	49.4	69.8	7/8-9	429	606
7/16-20	55.2	77.9	7/8-14	474	669
1/2-13	75.3	106.4	1-8	644	909
1/2-20	85.0	120.0	1-12	704	995
Metric Fasteners Class 8.8 and 10.9					
Size	Torque (ft-lb)		Size	Torque (ft-lb)	
	 Class 8.8	 Class 10.9		 Class 8.8	 Class 10.9
M6 x 1.00	7.7	11.1	M20 x 2.50	325	450
M8 x 1.25	19.5	26.9	M22 x 2.50	428	613
M10 x 1.50	38.5	53.3	M24 x 3.00	562	778
M12 x 1.75	67	93	M27 x 3.00	796	1139
M14 x 2.00	107	148	M30 x 3.50	1117	1545
M16 x 2.00	167	231	M33 x 3.50	1468	2101
M18 x 2.50	222	318	M36 x 4.00	1952	2701

These torque values apply to fasteners except those noted in the instructions.

INSTALLATION INSTRUCTIONS

NOTE: For easier assembly and installation, the vehicle and all snowplow components should be on a smooth, level, hard surface, such as concrete.

1. Place the skid plate assembly underneath the vehicle as shown.

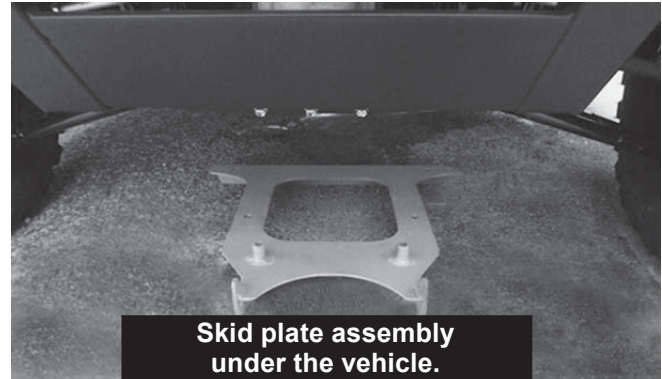

2. With the help of a second person, hold the skid plate assembly against the bottom of the frame. Center the skid plate from left to right. Be sure that the tail of the skid plate is between the two frame uprights. The passenger's side is shown in the picture below.

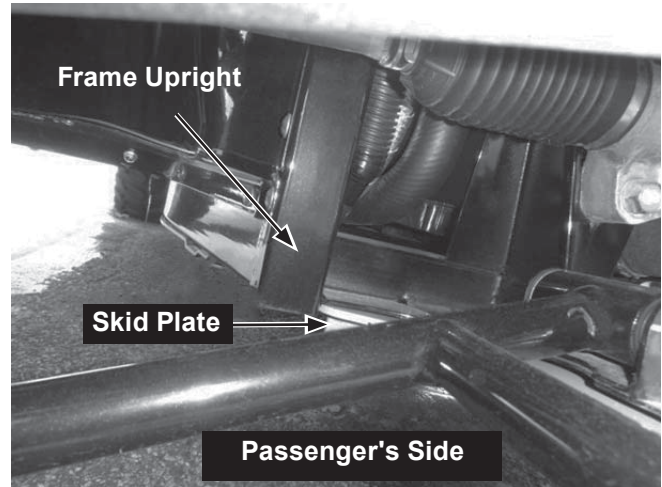

3. Tightly clamp the skid plate assembly to the vehicle on the both driver's and passenger's side using locking pliers in the location shown.

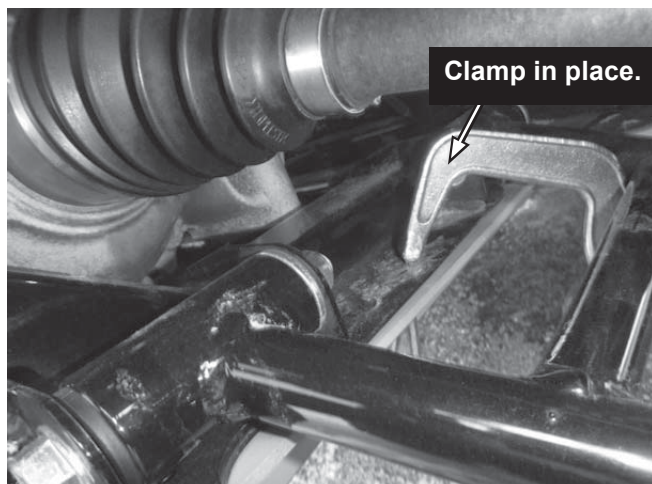

4. Measure the distance from the outer edge of the front brush guard to the edge of the skid plate runner as shown below. The distance on each side should be approximately 6-7/8".

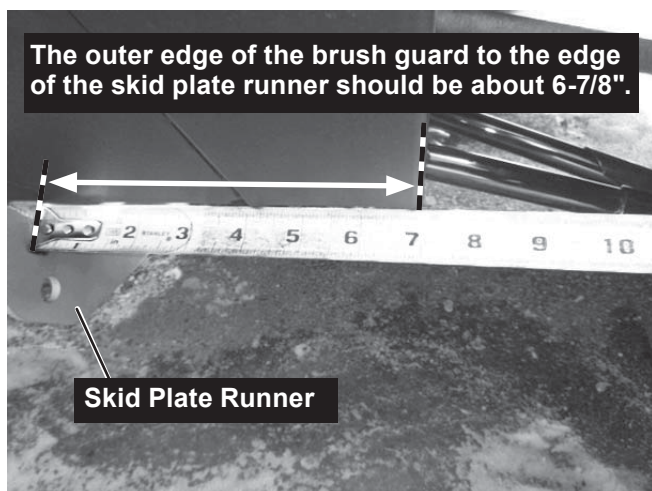

5. Measure the distance from the back edge of the front brush guard to the front edge of the skid plate as shown. Be sure that the distance is 3" on each side of the skid plate assembly. Adjust if needed.

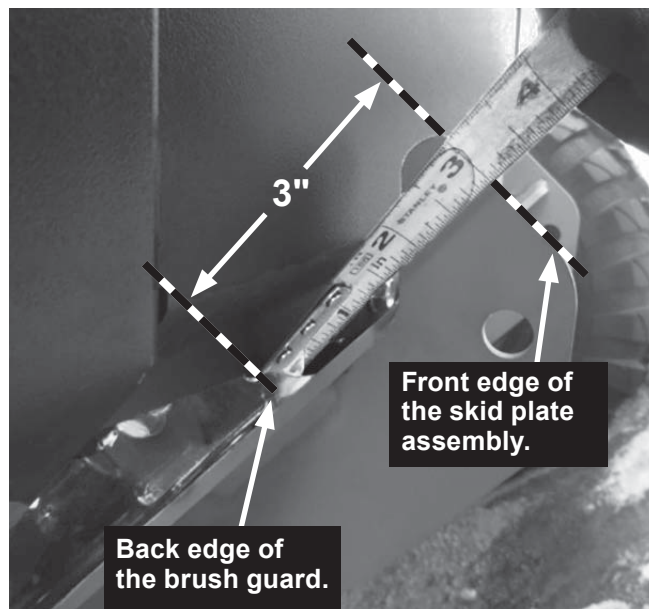

⚠ CAUTION

Before drilling holes, check to be sure that no vehicle wiring or other components could be damaged.

6. **Fore/Aft Positioning:** The front holes in the skid plate assembly will be used as guides for drilling holes into the UTV frame. Prior to drilling, adjust the skid plate assembly so that the front holes will be positioned where there is adequate clearance on the top surface of the UTV frame for placing the 7/16" washer and 7/16" locknut. A small pilot hole may be drilled to confirm the correct location.

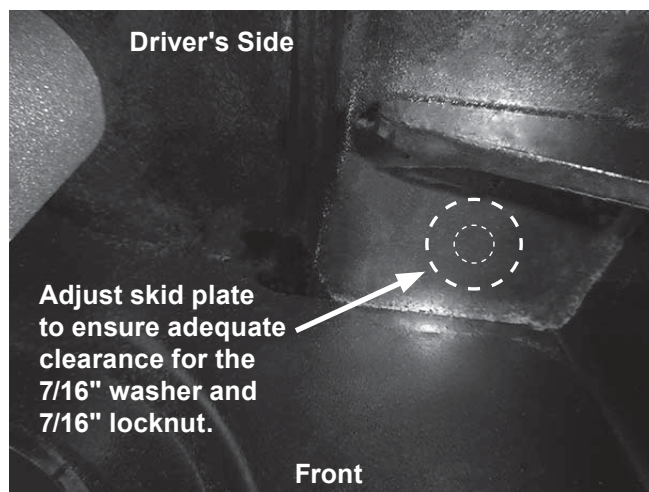

⚠ CAUTION

Before drilling holes, check to be sure that no vehicle wiring or other components could be damaged.

7. Once the skid plate assembly is positioned as described in Step 6, use the pre-existing holes in the skid plate as guides to drill two 15/32" holes in the front. Drill four 17/32" holes in the remaining locations.
8. Insert a 1/2" x 1-1/4" cap screw up through each hole in the middle of the skid plate assembly, and up through each hole in the rear. Secure with 1/2" locknuts and 1/2" washers against the UTV frame.
9. Insert the 7/16" x 2-1/2" cap screws up through both holes in the front of the skid plate assembly. Secure with 1/2" locknuts and 1/2" washers against the UTV frame.
10. Tighten all fasteners according to the torque chart. Remove the clamps.
11. Install the mount beam using four 1/2" x 1-1/4" cap screws and 1/2" locknuts. Ensure that the mount beam is level.
12. The distance from the ground to the lowest receiving hole on the mount beam should be approximately 10-1/4". Suspension adjustment may be necessary to achieve the proper ground clearance.

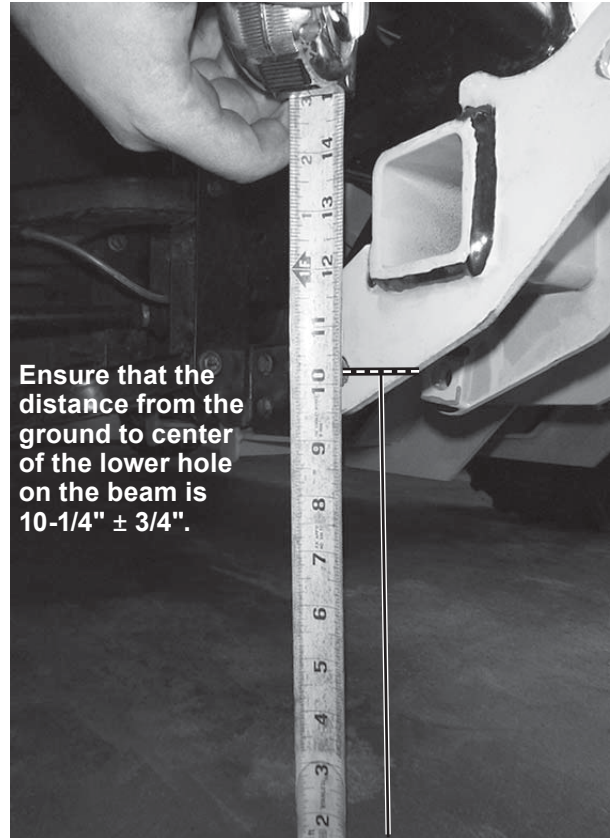

Ensure that the distance from the ground to center of the lower hole on the beam is 10-1/4" ± 3/4".

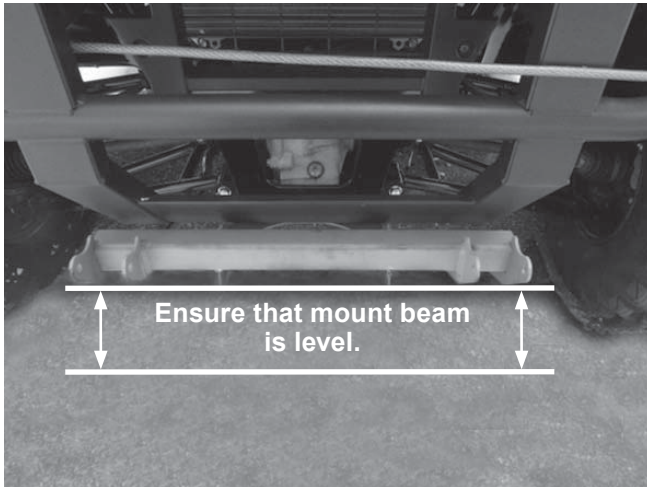

Ensure that mount beam is level.

13. Measure the distance between the mount beam rear hole and the ground. If it exceeds 11-1/2", install the accessory Height Adapter Plate Kit (PN 77555) to ensure optimum plowing performance.

NOTE: After five to ten hours of snowplow usage, retorque all mount assembly fasteners.

The company reserves the right under its product improvement policy to change construction or design details and furnish equipment when so altered without reference to illustrations or specifications used. This equipment manufacturer or the vehicle manufacturer may require or recommend optional equipment for snow removal. Do not exceed vehicle ratings with a snowplow. The company offers a limited warranty for all snowplows and accessories. See separately printed page for this important information.

Printed in U.S.A.