

35154

MOUNT KIT

John Deere XUV 835/865

2018—__

Installation Instructions

Heavy-duty front springs recommended.

▲ CAUTION

Read this document before installing the snowplow.

▲ CAUTION

See your sales outlet/website for specific vehicle application recommendations before installation. The online selection system has specific vehicle and snowplow requirements.

SAFETY DEFINITIONS

⚠ WARNING
 Indicates a potentially hazardous situation that, if not avoided, could result in death or serious personal injury.

⚠ CAUTION
 Indicates a potentially hazardous situation that, if not avoided, may result in minor or moderate injury. It may also be used to alert against unsafe practices.

NOTE: Indicates a situation or action that can lead to damage to your snowplow and vehicle or other property. Other useful information can also be described.

WARNING/CAUTION & INSTRUCTION LABELS

Become familiar with and inform users about the warning/caution and instruction labels on the back of the blade.

NOTE: If labels are missing or cannot be read, see your sales outlet.

Warning/Caution Label

⚠ WARNING

 Blade could drop unexpectedly, crushing or trapping limbs. Lower blade when vehicle is parked.

 Overloading could negatively affect vehicle handling. To avoid serious injury or death, do not exceed GVWR or GAWR including blade and ballast.

⚠ CAUTION

 Read Owner's Manual before operating or servicing snowplow.

 Transport speed should not exceed 45 mph (72 km/h). Further reduce speed under adverse travel conditions.

 Plowing speed should not exceed 10 mph (16 km/h).

See your sales outlet/website for specific vehicle application recommendations.

www.

Instruction Label

ATTACH

- Slowly drive vehicle forward to engage rear receiver pins into headgear slots. Apply vehicle parking brake.
- Hold down **lock lever** and move **hitch pin handle** out of the **handle lock notch**, allowing spring to move the **hitch pin handle** forward.
- Plug in electrical harness.
- Turn plow control in vehicle ON and activate FLOAT.
- Stand in front of **blade**. Push top of **headgear** toward vehicle to allow **hitch pins** to fully engage **hitch pin holes**.
- Verify the **lock pin** is engaged in the forward hole in the **lock pin bracket**.
- Remove **hairpin**, **adjustment pin**, & **stand**.

⚠ WARNING

Keep fingers away from snowplow and UTV attachment points.

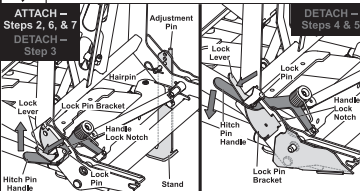

DETACH

- With blade straight, lower snowplow to the ground. Activate FLOAT, then turn plow control in vehicle OFF. Apply vehicle parking brake.
- Unplug electrical harness.
- Insert stand through slot in the passenger side headgear horn. Adjust stand as far down as possible, install adjustment pin, and secure with a hairpin.
- Hold down **lock lever** to disengage the **lock pin** and move the **hitch pin handle** rearward to fully disengage **hitch pins** from receivers.
- Move **hitch pin handle** into **handle lock notch**.

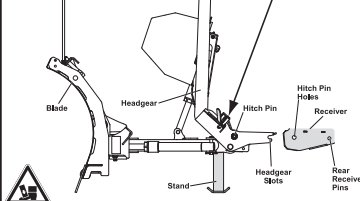

US patents 7,400,058; 7,737,576; 9,200,418.

Read Owner's Manual for complete instructions.

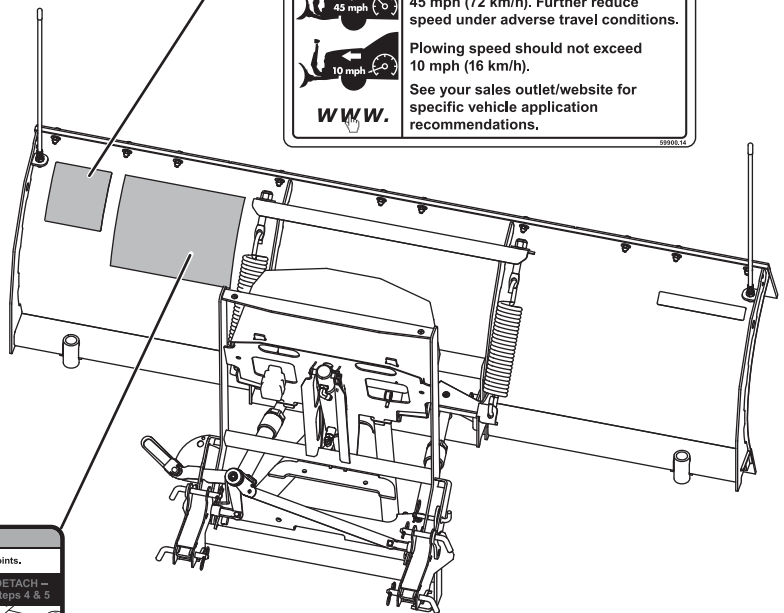

SAFETY PRECAUTIONS

Improper installation and operation could cause personal injury and/or equipment and property damage. Read and understand labels and the Owner's Manual before installing, operating, or making adjustments.

⚠ WARNING

Lower the blade when vehicle is parked. Temperature changes could change hydraulic pressure, causing the blade to drop unexpectedly or damaging hydraulic components. Failure to do this could result in serious personal injury.

⚠ WARNING

The driver shall keep bystanders clear of the blade when it is being raised, lowered, or angled. Do not stand between the vehicle and the blade or within 8 feet of a moving blade. A moving or falling blade could cause personal injury.

⚠ WARNING

Keep hands and feet clear of the blade and A-frame when mounting or removing the snowplow. Moving or falling assemblies could cause personal injury.

⚠ WARNING

Do not exceed GVWR or GAWR including the blade and ballast. The rating label is found on the driver-side vehicle door cornerpost.

⚠ WARNING

To prevent accidental movement of the blade, always turn the control OFF whenever the snowplow is not in use. The power indicator light will turn OFF.

⚠ WARNING

Remove blade assembly before placing vehicle on hoist.

⚠ CAUTION

Refer to the online selection system for minimum vehicle recommendations and ballast requirements.

PERSONAL SAFETY

- Remove the ignition key and put the vehicle in PARK or in gear to prevent others from starting the vehicle during installation or service.
- Wear only snug-fitting clothing while working on your vehicle or snowplow.
- Do not wear jewelry or a necktie, and secure long hair.
- Wear safety goggles to protect your eyes from battery acid, gasoline, dirt, and dust.
- Avoid touching hot surfaces such as the engine, radiator, hoses, and exhaust pipes.
- Always have a fire extinguisher rated BC handy, for flammable liquids and electrical fires.

FIRE AND EXPLOSION

⚠ WARNING

Gasoline is highly flammable and gasoline vapor is explosive. Never smoke while working on vehicle. Keep all open flames away from gasoline tank and lines. Wipe up any spilled gasoline immediately.

Be careful when using gasoline. Do not use gasoline to clean parts. Store only in approved containers away from sources of heat or flame.

CELL PHONES

A driver's first responsibility is the safe operation of the vehicle. The most important thing you can do to prevent a crash is to avoid distractions and pay attention to the road. Wait until it is safe to operate mobile communication equipment such as cell phones, text messaging devices, pagers, or two-way radios.

VENTILATION

⚠ WARNING

Vehicle exhaust contains lethal fumes. Breathing these fumes, even in low concentrations, can cause death. Never operate a vehicle in an enclosed area without venting exhaust to the outside.

NOISE

Airborne noise emission during use is below 70 dB(A) for the snowplow operator.









VIBRATION

Operating snowplow vibration does not exceed 2.5 m/s² to the hand-arm or 0.5 m/s² to the whole body.

TORQUE CHART

⚠ CAUTION

Read instructions before assembling. Fasteners should be finger tight until instructed to tighten according to the torque chart. Use standard methods and practices when attaching snowplow, including proper personal protective safety equipment.

Recommended Fastener Torque Chart					
Inch Fasteners Grade 5 and Grade 8					
Size	Torque (ft-lb)		Size	Torque (ft-lb)	
	 Grade 5	 Grade 8		 Grade 5	 Grade 8
1/4-20	8.4	11.9	9/16-12	109	154
1/4-28	9.7	13.7	9/16-18	121	171
5/16-18	17.4	24.6	5/8-11	150	212
5/16-24	19.2	27.3	5/8-18	170	240
3/8-16	30.8	43.6	3/4-10	269	376
3/8-24	35.0	49.4	3/4-16	297	420
7/16-14	49.4	69.8	7/8-9	429	606
7/16-20	55.2	77.9	7/8-14	474	669
1/2-13	75.3	106.4	1-8	644	909
1/2-20	85.0	120.0	1-12	704	995
Metric Fasteners Class 8.8 and 10.9					
Size	Torque (ft-lb)		Size	Torque (ft-lb)	
	 Class 8.8	 Class 10.9		 Class 8.8	 Class 10.9
M6 x 1.00	7.7	11.1	M20 x 2.50	325	450
M8 x 1.25	19.5	26.9	M22 x 2.50	428	613
M10 x 1.50	38.5	53.3	M24 x 3.00	562	778
M12 x 1.75	67	93	M27 x 3.00	796	1139
M14 x 2.00	107	148	M30 x 3.50	1117	1545
M16 x 2.00	167	231	M33 x 3.50	1468	2101
M18 x 2.50	222	318	M36 x 4.00	1952	2701
These torque values apply to fasteners except those noted in the instructions.					

INSTALLATION INSTRUCTIONS

NOTE: For easier assembly and installation, the vehicle and all snowplow components should be on a smooth, level, hard surface, such as concrete.

1. Remove the front skid plate.

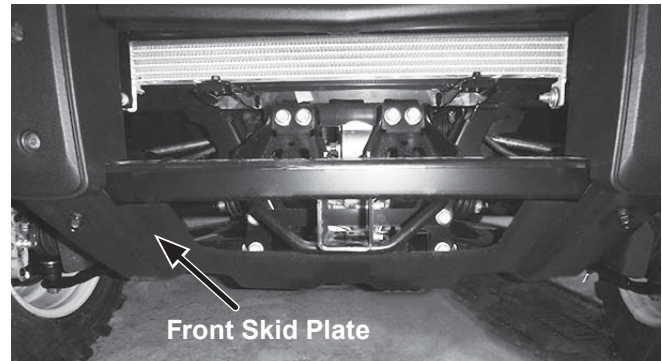

2. Starting on the passenger's side, install a 1/2" x 1-1/4" cap screw with 1/2" washer down through the upper winch plate in the location shown below. The cap screw and washer should contact the inner winch plate.

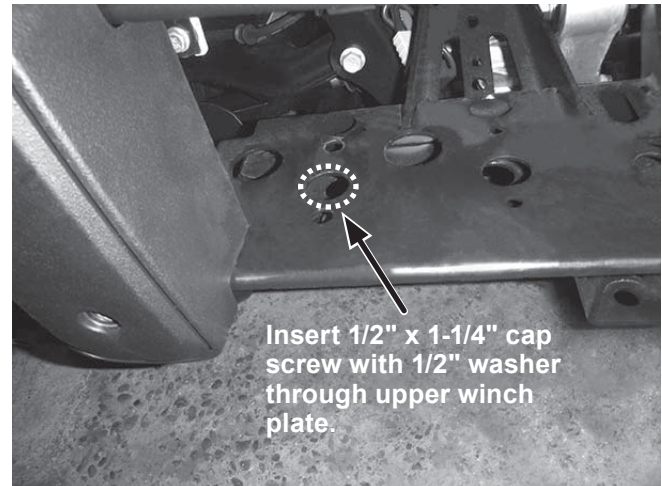

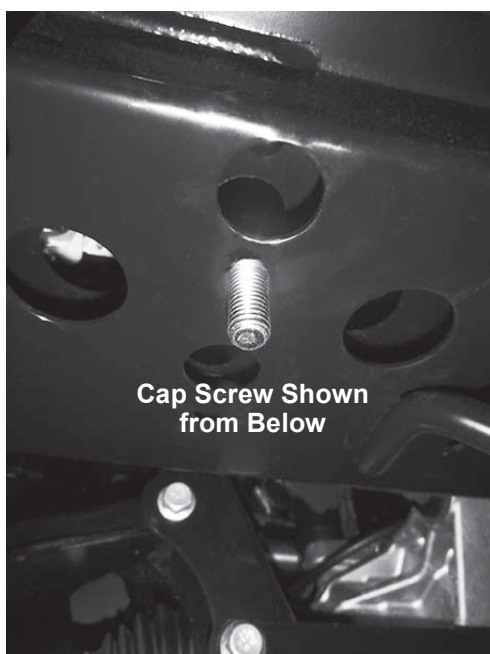
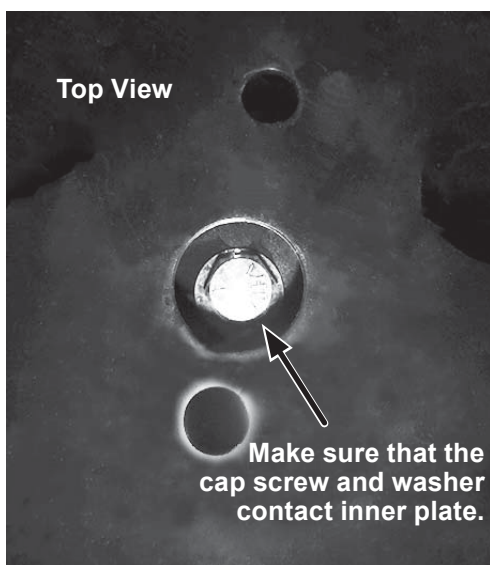

3. Install a hanger assembly over the 1/2" cap screw from Step 2. The cap screw should protrude through the middle hole of the hanger. Secure with a 1/2" locknut. Hand tighten.

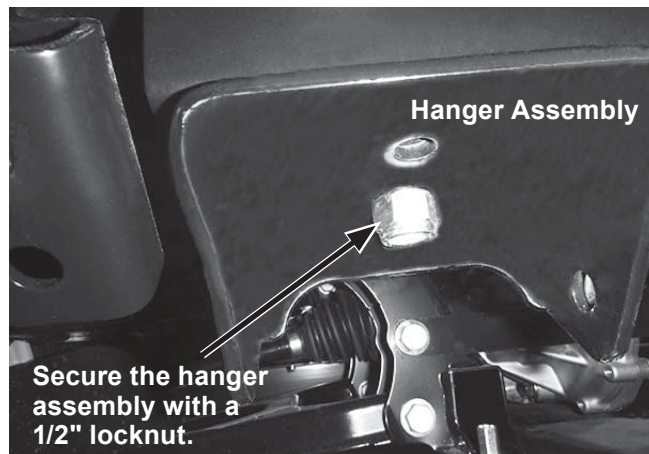

4. Place a bracket on top of the winch plate assembly, aligning the holes with the tubes of the hanger assembly installed in Step 3. Insert two 7/16" x 2-1/2" cap screws through the bracket and hanger assembly. Secure each cap screw with a 7/16" locknut. Hand tighten.

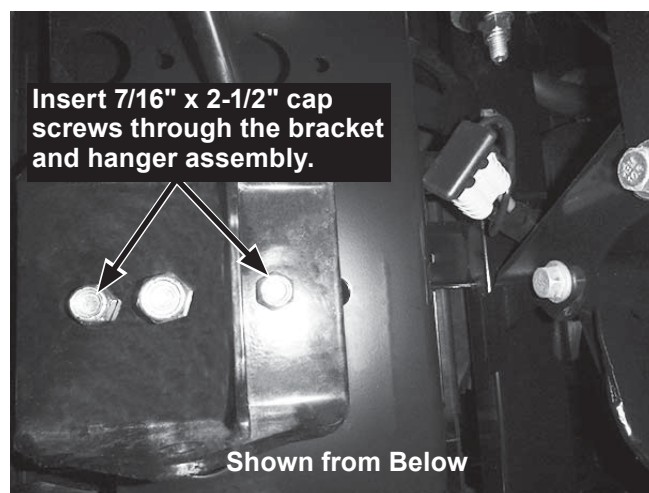
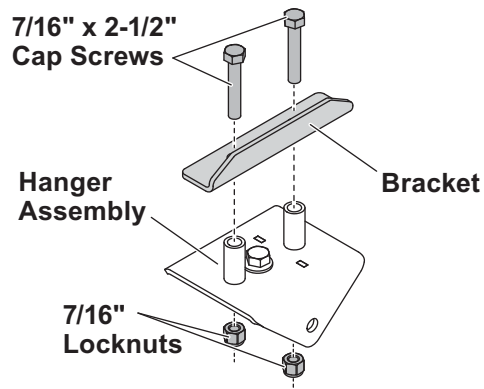

- 5. Tighten the 7/16" x 2-1/2" cap screw and the 1/2" x 1-1/4" cap screw installed in Step 2 according to the torque chart. The top of the 1/2" cap screw is accessible through the back of the winch plate.

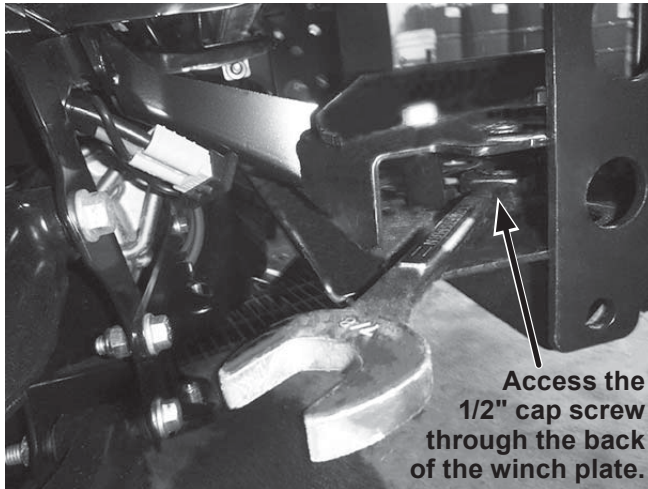

- 6. Repeat Steps 2–5 on the driver's side.

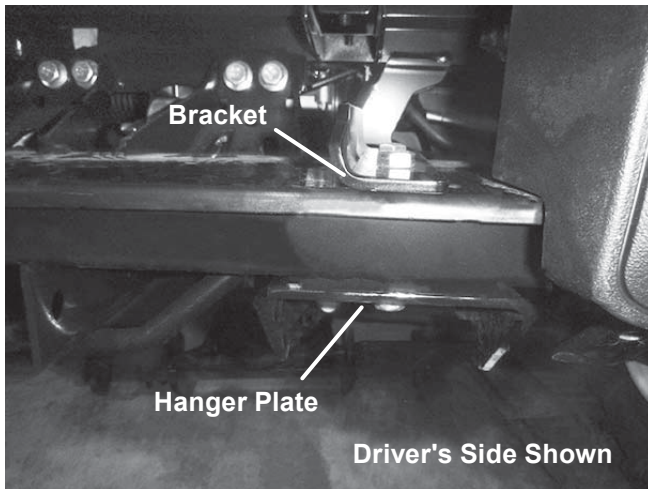

- 7. Install a 1/2" x 1-1/4" cap screw on handle into the frame on the passenger's side. Insert the fastener through the frontmost hole; bend the handle as necessary. Install a second cap screw on handle farther into the frame and through the second hole rearward from where the first cap screw on handle was inserted.

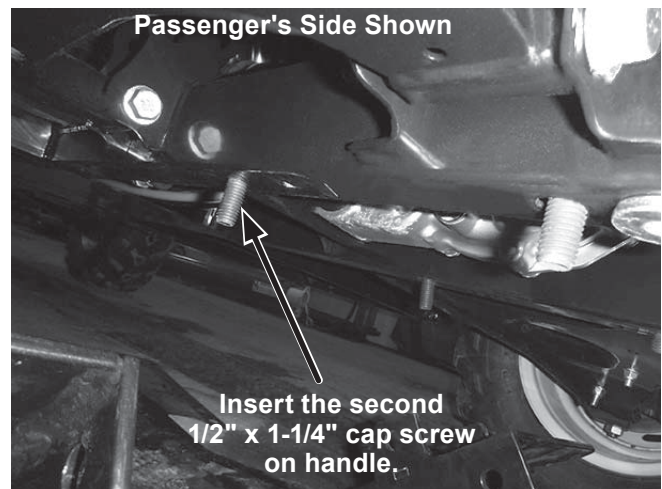
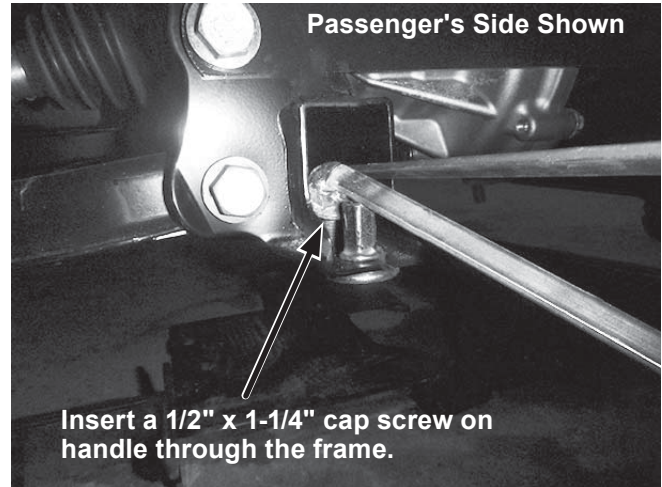

- 8. Repeat Step 7 on the driver's side.

- Place the skid plate assembly up against the vehicle frame, allowing the cap screws on handles to protrude through the corresponding holes in the assembly. The front portion of the skid plate assembly should line up with the hanger assemblies as shown.

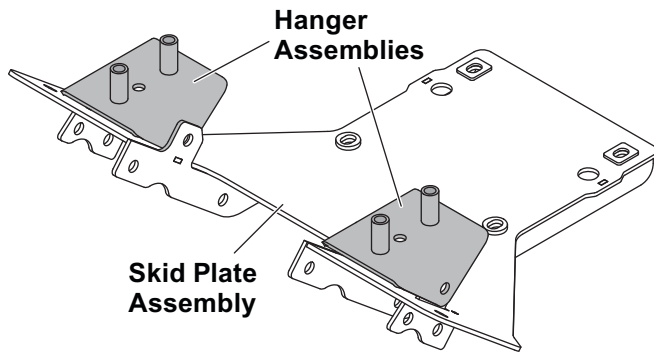

Secure the cap screws on handles with 1/2" washers and 1/2" locknuts. Hand tighten.

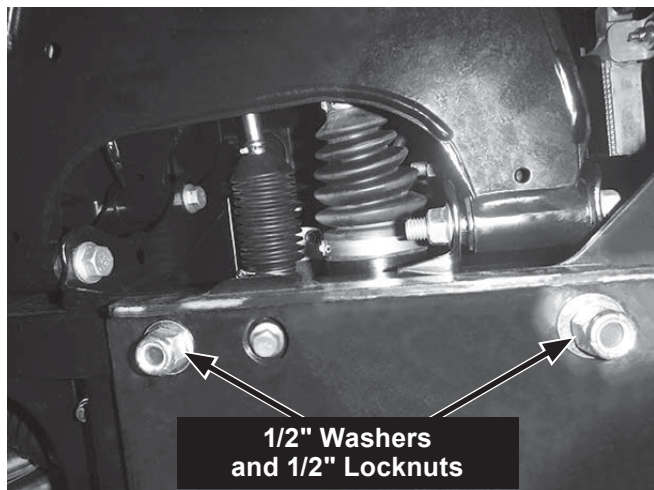

- Fasten the skid plate assembly to the hanger brackets using two 1/2" x 1-1/4" cap screws on each side. Secure with 1/2" locknuts and hand tighten.

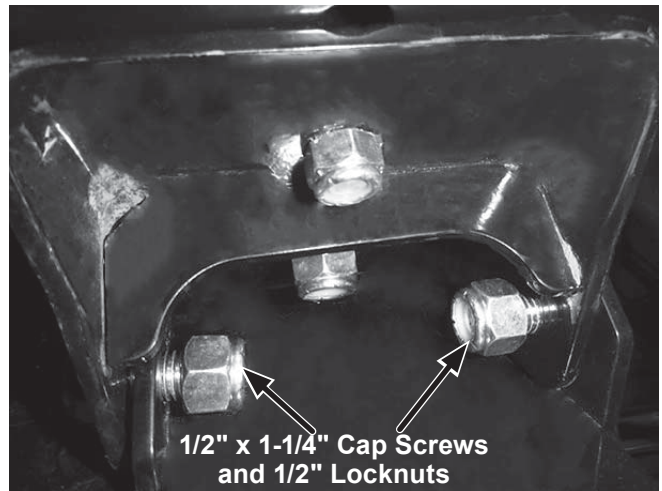

- Install a 3/8" x 1" cap screw with a 3/8" flat washer through the outer hole of the skid plate assembly on the passenger's side. Secure with a 3/8" washer and 3/8" locknut. Hand tighten.

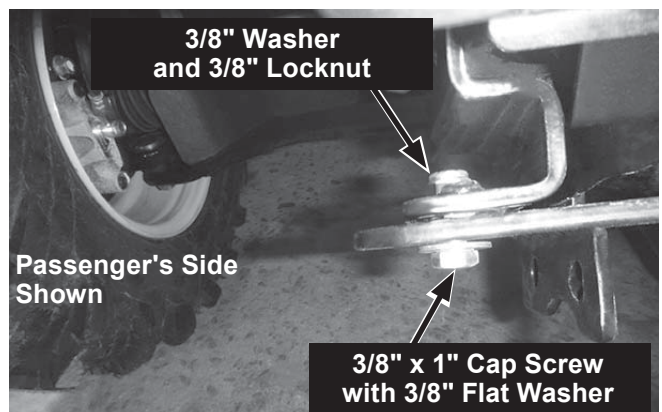

- Repeat Step 11 on the driver's side.

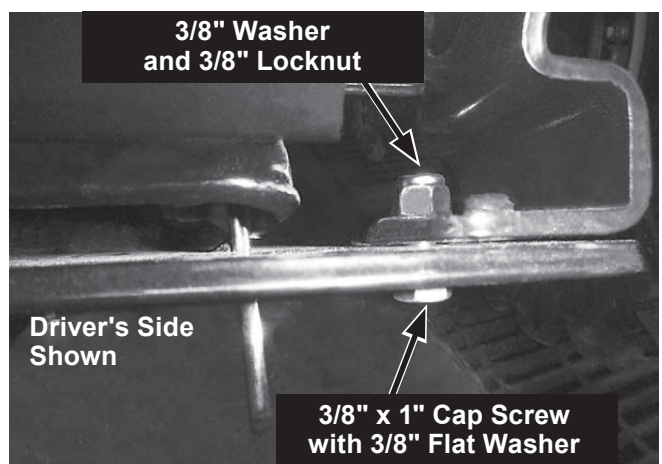

13. Put the mount beam in place and fasten with eight 1/2" x 1-1/4" cap screws and 1/2" locknuts. Hand tighten.

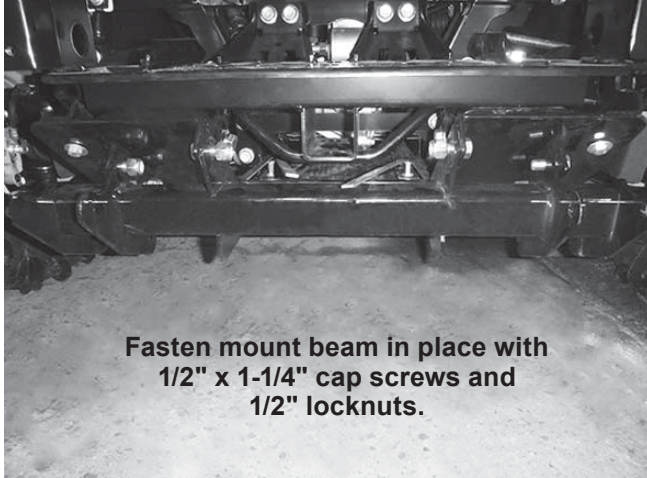

14. Tighten all hardware from Steps 7–13 according to the torque chart.
15. Measure the distance between the mount beam rear hole and the ground. If it exceeds 11-1/2", install the accessory Height Adapter Plate Kit (PN 77555) to ensure optimum plowing performance.

16. Trim the cap screw handles from Step 9 as short as possible.
17. Set the front spring preload to its maximum condition when snowplow is attached. See the vehicle owner's manual for suspension adjustment procedure.

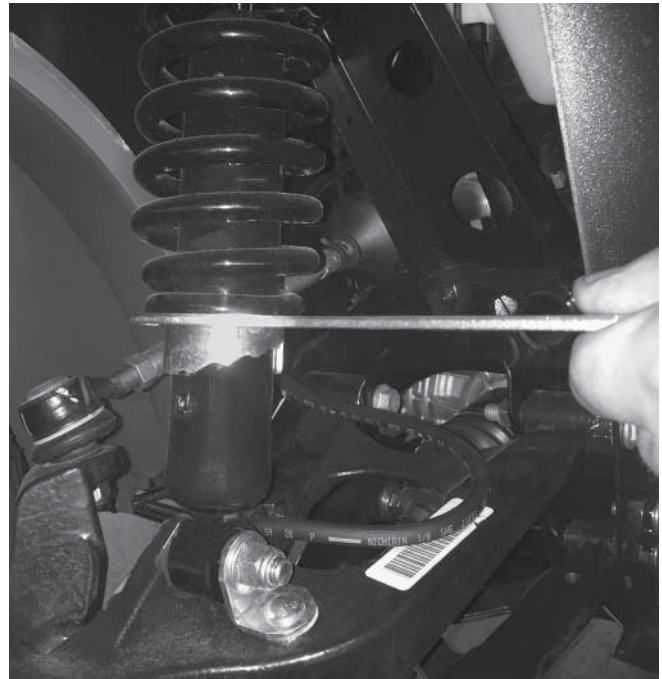

NOTE: After five to ten hours of snowplow usage, retorque all mount assembly fasteners.

The company reserves the right under its product improvement policy to change construction or design details and furnish equipment when so altered without reference to illustrations or specifications used. This equipment manufacturer or the vehicle manufacturer may require or recommend optional equipment for snow removal. Do not exceed vehicle ratings with a snowplow. The company offers a limited warranty for all snowplows and accessories. See separately printed page for this important information.